



KONICA MINOLTA

bizhub 3301 P

User's Guide

2015. 2

A63P-9571-00A

Contents

1—Safety information.....	8
2—Learning about the printer	13
Finding information about the printer	13
Selecting a location for the printer	14
Printer configurations	15
3—Additional printer setup.....	17
Installing internal options	17
Available internal options	17
Accessing the controller board	17
Installing an optional card.....	18
Installing hardware options.....	21
Installing optional trays.....	21
Attaching cables	23
Setting up the printer software.....	24
Installing the printer driver	24
Adding available options in the printer driver	24
Networking.....	25
Preparing to set up the printer on an Ethernet network	25
Installing the printer on an Ethernet network.....	25
Preparing to set up the printer on a wireless network.....	27
Connecting the printer to a wireless network using Wi-Fi Protected Setup	28
Connecting the printer to a wireless network using the printer software.....	29
Connecting the printer to a wireless network using the Embedded Web Server.....	30
Printing menu settings and network setup pages.....	31
4— Using the printer control panel	32
Understanding the colors of the Sleep button and indicator lights	33
Installing the Local Printer Settings Utility	34
Using the Local Printer Settings Utility	34

User's Guide

5—Loading paper and specialty media..... 35

- Setting the paper size and type 35
- Configuring Universal paper settings..... 35
- Using the standard bin and paper stop..... 36
- Loading trays 37
- Loading the multipurpose feeder 41
- Linking and unlinking trays 45
 - Linking and unlinking trays 45
 - Configuring a custom paper type 46
 - Assigning a custom paper type 46

6—Paper and specialty media guide 47

- Paper guidelines 47
 - Paper characteristics 47
 - Unacceptable paper 48
 - Selecting paper..... 48
 - Selecting preprinted forms and letterhead 49
 - Storing paper 49
- Using specialty media 50
 - Tips on using card stock..... 50
 - Tips on using envelopes..... 50
 - Tips on using labels..... 51
 - Tips on using letterhead 51
 - Tips on using transparencies 52
- Supported paper sizes, types, and weights 52
 - Supported paper sizes 52
 - Supported paper types and weights 54

7—Printing..... 56

- Printing a document..... 56
 - Printing a document..... 56
 - Adjusting toner darkness 56

User's Guide

Printing information pages	57
Canceling a print job	57
Canceling a print job from the printer control panel	57
Canceling a print job from the computer	58
8—Saving the environment.....	59
Saving paper and toner	59
Using recycled paper.....	59
Conserving supplies	59
9—Managing the printer.....	60
Finding advanced networking and administrator information	60
Copying printer settings to other printers.....	60
Configuring supply notifications from the Embedded Web Server	60
Printer management	61
Accessing the remote control panel	61
Viewing reports.....	62
Restoring factory default settings	62
Creating a printer control panel PIN	62
Saving energy.....	63
Adjusting Sleep mode.....	65
10—Securing the printer	66
Using the security lock feature.....	66
Statement of Volatility	66
Erasing volatile memory	67
Erasing non-volatile memory	67
11—Understanding the printer menus.....	68
Menus list.....	68
Paper menu	69
Default Source menu.....	69
Paper Size/Type menu.....	70
Configure MP menu.....	73

User's Guide

Substitute Size menu	73
Paper Texture menu.....	74
Paper Weight menu.....	76
Paper Loading menu	78
Custom Types menu	79
Universal Setup menu	80
Reports menu	81
Reports menu.....	81
Network/Ports menu	82
Active NIC menu.....	82
Standard Network or Network [x] menu	82
Reports menu	84
Wireless menu.....	84
Network Card menu.....	85
TCP/IP menu	86
IPv6 menu	88
Standard USB menu.....	89
Standard Parallel menu.....	91
AppleTalk menu.....	94
SMTP Setup menu	95
Security menu	96
Set Date and Time menu	96
Settings menu	97
General Settings menu.....	97
Print Settings	102
12—Clearing jams.....	117
Avoiding jams.....	117
Understanding jam messages and locations.....	118
Jam, front door [20y.xx].....	119
Jam, rear door [20y.xx].....	123

User's Guide

- Jam, standard bin [20y.xx] 124
- Jam, pull tray 1. Push down green flap. [23y.xx]..... 125
- Jam, tray [x] [24y.xx]..... 126
- Jam, MP feeder [250.xx] 127
- 13—Maintaining the printer 129
 - Cleaning the printer 129
 - Checking the status of parts and supplies 129
 - Estimated number of remaining pages 130
 - Ordering supplies 130
 - Using genuine KONICA MINOLTA parts and supplies 130
 - Ordering toner cartridges 130
 - Ordering an imaging unit 131
 - Storing supplies 131
 - Replacing supplies 132
 - Replacing the toner cartridge 132
 - Replacing the imaging unit 133
 - Moving the printer 135
 - Before moving the printer 135
 - Moving the printer to another location 136
 - Shipping the printer 136
- 14—Troubleshooting 137
 - Understanding the printer messages 137
 - Solving printer problems 143
 - Basic printer problems 143
 - Option problems 146
 - Paper feed problems 150
 - Solving print problems 151
 - Printing problems 151
 - Print quality problems 159
 - Embedded Web Server does not open 185

User's Guide

Contacting technical support 187

15—Notices 188

 Copyright notice 188

 Edition notice 188

 Trademarks 188

 Software License Agreement 188

 Legal restrictions on reproduction 190

 FIRMWARE UPDATES 190

 PRINTER LICENSE 191

 CARTRIDGE LICENSE AGREEMENT 191

 Fuser/Imaging Unit License - Single Use: Please read before opening 191

 Noise emission levels 192

 For EU member states only 192

 India E-Waste notice 192

 Product disposal 192

 ENERGY STAR 193

 What is an ENERGY STAR product? 193

 Temperature information 193

 Power consumption 193

 Product power consumption 193

 Sleep Mode 194

 Hibernate Mode 194

 Off mode 195

 Total energy usage 195

1—Safety information

Connect the power cord directly to an appropriately rated and properly grounded electrical outlet that is near the product and easily accessible.

 **CAUTION—POTENTIAL INJURY:** Do not use this product with extension cords, multioutlet power strips, multioutlet extenders, or other types of surge or UPS devices. The power rating capacity of these types of accessories can be easily overloaded by a laser printer and may result in poor printer performance, property damage, or potential fire.

Do not place or use this product near water or wet locations.

 **CAUTION—POTENTIAL INJURY:** This product uses a laser. Use of controls or adjustments or performance of procedures other than those specified herein may result in hazardous radiation exposure.

This product uses a printing process that heats the print media, and the heat may cause the media to release emissions. You must understand the section in your operating instructions that discusses the guidelines for selecting print media to avoid the possibility of harmful emissions.

 **CAUTION—POTENTIAL INJURY:** The lithium battery in this product is not intended to be replaced. There is a danger of explosion if a lithium battery is incorrectly replaced. Do not recharge, disassemble, or incinerate a lithium battery. Discard used lithium batteries according to the manufacturer's instructions and local regulations.

 **CAUTION—POTENTIAL INJURY:** Before moving the printer, follow these guidelines to avoid personal injury or printer damage:

- Turn the printer off using the power switch, and then unplug the power cord from the electrical outlet.
- Disconnect all cords and cables from the printer before moving it.
- If an optional tray is installed, then remove it from the printer. To remove the optional tray, slide the latch on the right side of the tray toward the front of the tray until it *clicks* into place.
- Use the handholds located on both sides of the printer to lift it.
- Make sure your fingers are not under the printer when you set it down.
- Before setting up the printer, make sure there is adequate clearance around it.

Use only the power cord provided with this product or the manufacturer's authorized replacement.

 **CAUTION—HOT SURFACE:** The inside of the printer might be hot. To reduce the risk of injury from a hot component, allow the surface to cool before touching it.

 **CAUTION—SHOCK HAZARD:** If you are accessing the controller board or installing optional hardware or memory devices sometime after setting up the printer, then turn the printer off, and unplug the power cord from the electrical outlet before continuing. If you have any other devices attached to the printer, then turn them off as well, and unplug any cables going into the printer.

 **CAUTION—SHOCK HAZARD:** Make sure that all external connections (such as Ethernet and telephone system connections) are properly installed in their marked plug-in ports.

User's Guide

This product is designed, tested, and approved to meet strict global safety standards with the use of specific manufacturer's components. The safety features of some parts may not always be obvious. The manufacturer is not responsible for the use of other replacement parts.

 **CAUTION—POTENTIAL INJURY:** Do not cut, twist, bind, crush, or place heavy objects on the power cord. Do not subject the power cord to abrasion or stress. Do not pinch the power cord between objects such as furniture and walls. If any of these things happen, a risk of fire or electrical shock results. Inspect the power cord regularly for signs of such problems. Remove the power cord from the electrical outlet before inspecting it.

Refer service or repairs, other than those described in the user documentation, to a service representative.

 **CAUTION—SHOCK HAZARD:** To avoid the risk of electrical shock when cleaning the exterior of the printer, unplug the power cord from the electrical outlet and disconnect all cables from the printer before proceeding.



 **CAUTION—POTENTIAL INJURY:** To reduce the risk of equipment instability, load each tray separately. Keep all other trays closed until needed.

 **CAUTION—SHOCK HAZARD:** Do not set up this product or make any electrical or cabling connections, such as the fax feature, power cord, or telephone, during a lightning storm.





SAVE THESE INSTRUCTIONS.







■ **Warning and Caution Symbols**





The labels and symbols used in this manual and on the printer help prevent injury to the operator and others around the printer as well as damage to property. Those labels and symbols have the following meanings:









 WARNING	Ignoring this warning could cause serious injury or even death.
 CAUTION	Ignoring this caution could cause injury or damage to property.



● **Meaning of Symbols**

-   indicates a danger against which you should take precaution.
The symbol shown to the left warns against possible electrical shock.
-  indicates a prohibited course of action.
The symbol shown to the left warns against dismantling the device.
-  indicates an imperative course of action.
The symbol shown to the left indicates that you must unplug the device.

 WARNING	
	<ul style="list-style-type: none"> • Do not attempt to remove any of the covers and panels attached to the printer. Some printers have a high-voltage part or a laser beam source inside that could cause an electrical shock or blindness. • Do not modify the printer, as a fire, electrical shock, or breakdown could result. If the printer employs a laser, the laser beam source could cause blindness.
	<ul style="list-style-type: none"> • Use only the power cord supplied in the package. If a power cord is not supplied, use only the power cord and plug that are specified in the user documentation. Failure to use this cord could result in a fire or electrical shock. • Use the power cord supplied in the package only with this printer; NEVER use it for another product. Failure to observe this precaution could result in a fire or electrical shock. • Use only a power source of the specified voltage. Failure to do that could result in a fire or electrical shock.
	<ul style="list-style-type: none"> • Do not use a multiple outlet adapter to connect any other products. Exceeding the rating of a power outlet could result in a fire or electrical shock. • Do not use an extension cord, as this could cause a fire or electrical shock. Contact your authorized service provider if an extension cord is required. • Do not scratch, rub, place a heavy object on, heat, twist, bend, pull on, or damage the power cord. Use of a damaged power cord (exposed core wire, broken wire, etc.) could result in a fire or breakdown. Should any of the described conditions have occurred, immediately turn off and unplug the printer, and then call your authorized service provider.
	Do not unplug and plug in the power cord with wet hands, as an electrical shock could result.
	Plug the power cord all the way into the power outlet. Failure to do this could result in a fire or electrical shock.

 WARNING	
	Connect the power cord to an electrical outlet that is equipped with a grounding terminal.
	Do not place metal clips, any other small metallic objects, or a container containing liquid on the printer. Liquid and metallic objects dropped inside the printer could result in a fire, electrical shock, or breakdown. Should liquid, a piece of metal, or any other foreign matter fall inside the printer, immediately turn off and unplug the printer, and then call your authorized service provider.
	<ul style="list-style-type: none"> Do not use your printer if it becomes excessively hot, emits smoke or an unusual odor, or makes an unusual noise. Immediately turn off and unplug the printer, and then call your authorized service provider. If you continue using the printer, a fire or electrical shock could result. Do not use this printer if it has been dropped or the cover has been damaged. Immediately turn off and unplug the printer, and then call your authorized service provider. If you continue using the printer, a fire or electrical shock could result.
	Do not burn toner cartridges or toner. The hot toner may scatter and cause burns or other damage.

 CAUTION	
	<ul style="list-style-type: none"> Do not expose the printer to dust, soot, or steam, or place it near a kitchen table, bath, or humidifier. A fire, electrical shock, or breakdown could result. Do not place the printer on an unstable or tilted table, or in a location subject to a lot of vibration and shock. The printer could fall, causing personal injury or mechanical breakdown.
	After installing this product, place it on a sturdy base. If the printer moves or falls, it may cause personal injury.
	Certain areas inside the printer may become very hot and cause burns. When checking the inside of the printer for malfunctions such as media jams, do not touch the locations (around the fusing unit, etc.) labeled "Caution HOT."
	<ul style="list-style-type: none"> Do not obstruct the printer's ventilation grilles. Heat could accumulate inside the printer, resulting in a fire or malfunction. Do not use flammable sprays, liquids, or gases near the printer, as a fire could result.
	<ul style="list-style-type: none"> Do not pull on the power cord when unplugging it. Pulling on the power cord could damage it, resulting in a fire or electrical shock. Do not place any objects around the power plug, as it may be difficult to unplug when an emergency occurs.
	<ul style="list-style-type: none"> Do not store toner cartridges and PC drum units near computer disks or watches that are susceptible to magnetism, as they could cause them to malfunction. Do not leave toner cartridges or PC drum units within reach of children. Ingesting toner could be harmful to your health. Do not force open the toner-related parts (toner units, PC drum units, imaging units or developing units). If toner tumbles from the toner bottle, take utmost care to avoid inhaling it or even getting skin contact. Do not use stapled paper, conductive paper (such as silver paper or carbon paper) or treated heat-sensitive/inkjet paper, otherwise a fire may result.
	<ul style="list-style-type: none"> If toner lands on your skin or clothing, wash thoroughly with soap and water. If you inhale toner, move to a place with fresh air and gargle with a lot of water repeatedly. Should you get symptoms such as coughing, seek medical advice. If you get toner into your eyes, immediately rinse them with running water for over 15 minutes. Seek medical advice if irritation persists. If you swallow toner, rinse out your mouth and drink a few glasses of water. Seek medical advice if necessary.

 CAUTION
 <ul style="list-style-type: none">• Whenever moving the printer, be sure to disconnect the power cord and other cables. Failure to do this could damage the cord or cable, resulting in a fire, electrical shock, or breakdown.• Unplug the printer if you are not going to use it for a long period of time.
 <ul style="list-style-type: none">• When moving the printer, always hold it as specified in the user documentation. If the printer falls, it may cause severe personal injury and/or be damaged.• Use the printer only in a well-ventilated location. Operating the printer in a poorly ventilated room for an extended period of time could be harmful to your health. Ventilate the room at regular intervals.• Remove the power cord from the outlet more than once a year and clean between the plug terminals. Dust that accumulates between the plug terminals may cause a fire.

2—Learning about the printer

Finding information about the printer

What are you looking for?	Find it here
<p>Initial setup instructions:</p> <ul style="list-style-type: none"> • Connecting the printer • Installing the printer software 	<p>Setup documentation—The setup documentation came with the printer.</p>
<p>Additional setup and instructions for using the printer:</p> <ul style="list-style-type: none"> • Selecting and storing paper and specialty media • Loading paper • Configuring printer settings • Viewing and printing documents and photos • Setting up and using the printer software • Configuring the printer on a network • Caring for and maintaining the printer • Troubleshooting and solving problems 	<p><i>User's Guide</i> and <i>Quick Reference Guide</i>—The guides are available on the <i>Printer Driver and Documentations</i> CD.</p> <p>Note: These guides are also available in other languages.</p>
<p>Instructions for:</p> <ul style="list-style-type: none"> • Connecting the printer to an Ethernet network • Troubleshooting printer connection problems 	<p><i>Networking Guide</i>—Insert the <i>Printer Driver and Documentations</i> CD, and then click Documentation on the CD menu. On the left navigation pane, click User's Guide and other publications, and then click Networking Guide.</p>
<p>The latest supplemental information, updates, and technical support:</p> <ul style="list-style-type: none"> • Documentation • Driver downloads 	<p>KONICA MINOLTA Support Web site— http://www.konicaminolta.com</p> <p>Note: Record the following information (located on the store receipt and at the back of the printer), and have it ready when you contact technical support so that they may serve you faster:</p> <ul style="list-style-type: none"> • Machine Type number • Serial number • Date purchased • Store where purchased
<p>Warranty information</p>	<p>Warranty information varies by country or region.</p>

Selecting a location for the printer

When selecting a location for the printer, leave enough room to open trays, covers, and doors. If you plan to install any hardware options, then leave enough room for them also. It is important to:

- Set up the printer near a properly grounded and easily accessible electrical outlet.
- Make sure airflow in the room meets the latest revision of the ASHRAE 62 standard or the CEN Technical Committee 156 standard.
- Provide a flat, sturdy, and stable surface.
- Keep the printer:
 - Clean, dry, and free of dust.
 - Away from stray staples and paper clips.
 - Away from the direct airflow of air conditioners, heaters, or ventilators.
 - Free from direct sunlight and humidity extremes.
- Observe the recommended temperatures and avoid fluctuations.

Ambient temperature	15.6 to 32.2°C (60 to 90°F)
Storage temperature	-20 to 40°C (-4 to 104°F)

- Allow the following recommended amount of space around the printer for proper ventilation:

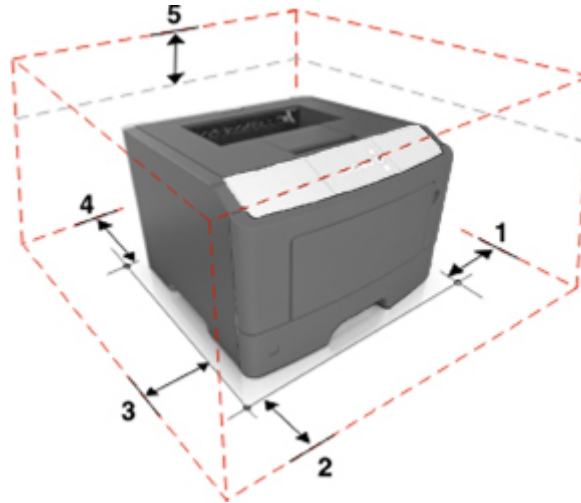

1	Right side	110 mm (4.33 in.)
2	Front	305 mm (12 in.)

3	Left side	65 mm (2.56 in.)
4	Rear	100 mm (3.94 in.)
5	Top	305 mm (12 in.)

Printer configurations

⚠ CAUTION—POTENTIAL INJURY: To reduce the risk of equipment instability, load each tray separately. Keep all other trays closed until needed.

You can configure your printer by adding one optional 250- or 550-sheet tray. For instructions on installing the optional tray, see [Installing optional trays](#).

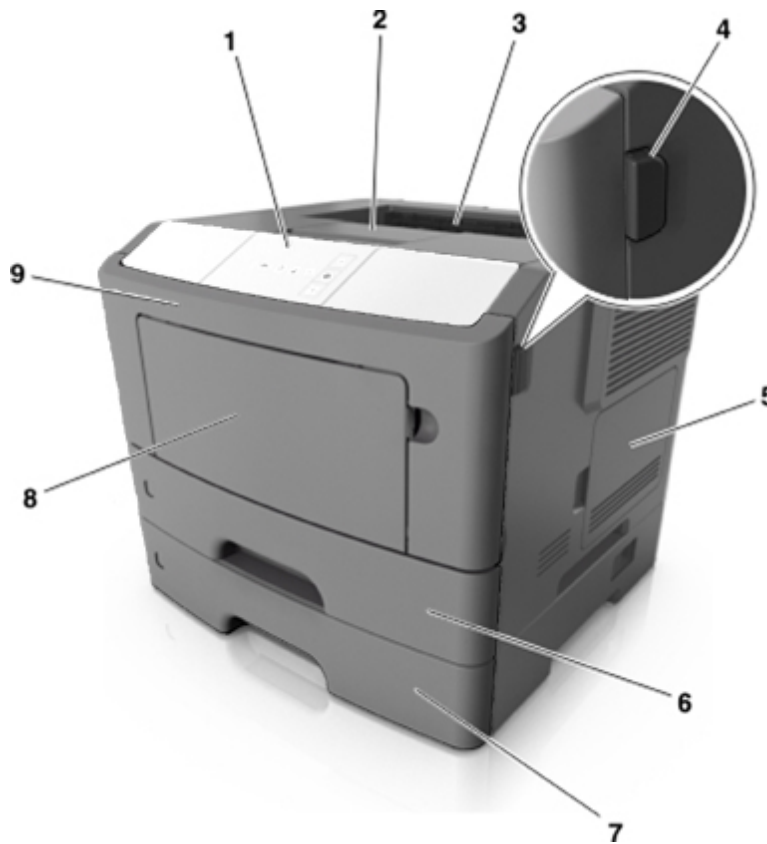

1	Control panel
2	Paper stop
3	Standard bin
4	Front door release button

User's Guide

5	Controller board access cover
6	Standard 250-sheet tray
7	Optional 250- or 550-sheet tray
8	50-sheet multipurpose feeder
9	Front door

3—Additional printer setup

Installing internal options

⚠ CAUTION—SHOCK HAZARD: If you are accessing the controller board or installing optional hardware or memory devices sometime after setting up the printer, then turn the printer off, and unplug the power cord from the electrical outlet before continuing. If you have any other devices attached to the printer, then turn them off as well, and unplug any cables going into the printer.

Warning—Potential Damage: Controller board electronic components are easily damaged by static electricity. Touch a metal surface on the printer before touching any controller board electronic components or connectors.

Available internal options

- Flash memory
 - Fonts
 - Firmware

Accessing the controller board

⚠ CAUTION—SHOCK HAZARD: If you are accessing the controller board or installing optional hardware or memory devices sometime after setting up the printer, then turn the printer off, and unplug the power cord from the electrical outlet before continuing. If you have any other devices attached to the printer, then turn them off as well, and unplug any cables going into the printer.

1. Open the controller board access door.

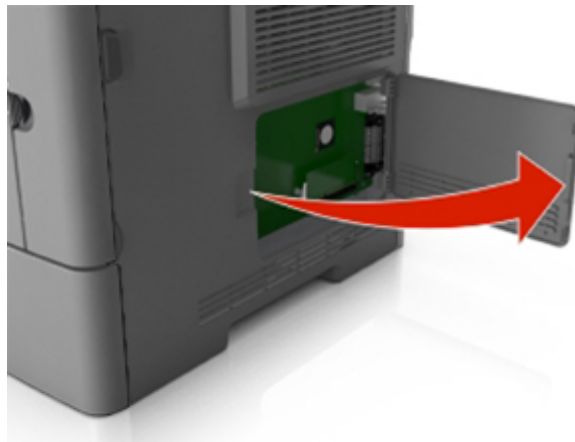

2. Locate the memory card connector.

Warning—Potential Damage: Controller board electronic components are easily damaged by static electricity. Touch a metal surface on the printer before touching any controller board electronic components or connectors.

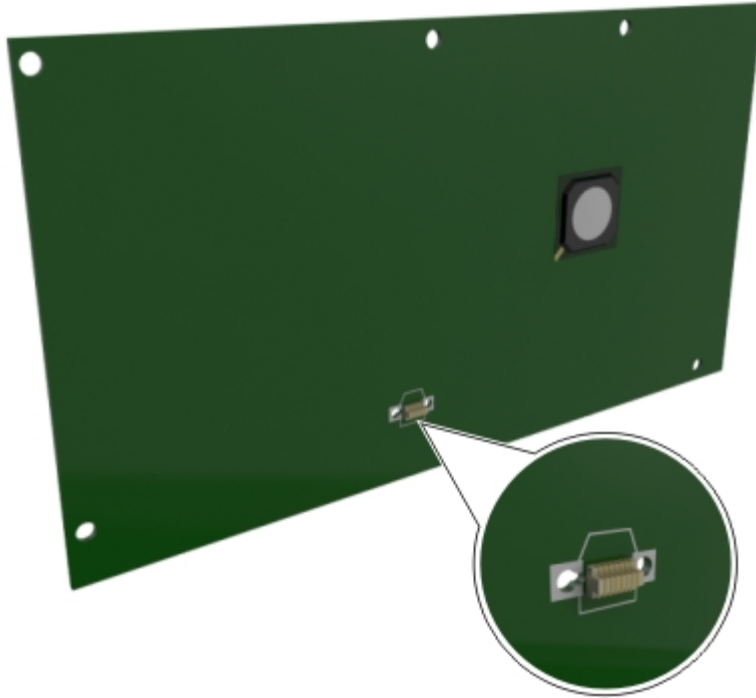

Installing an optional card

⚠ CAUTION—SHOCK HAZARD: If you are accessing the controller board or installing optional hardware or memory devices sometime after setting up the printer, then turn the printer off, and unplug the power cord from the electrical outlet before continuing. If you have any other devices attached to the printer, then turn them off as well, and unplug any cables going into the printer.

Warning—Potential Damage: Controller board electronic components are easily damaged by static electricity. Touch a metal surface on the printer before touching any controller board electronic components or connectors.

1. Access the controller board.

For more information, see [Accessing the controller board](#).

2. Unpack the optional card.

Warning—Potential Damage: Avoid touching the connection points along the edge of the card.

3. Holding the card by its sides, align the plastic pins (1) on the card with the holes (2) on the controller board.

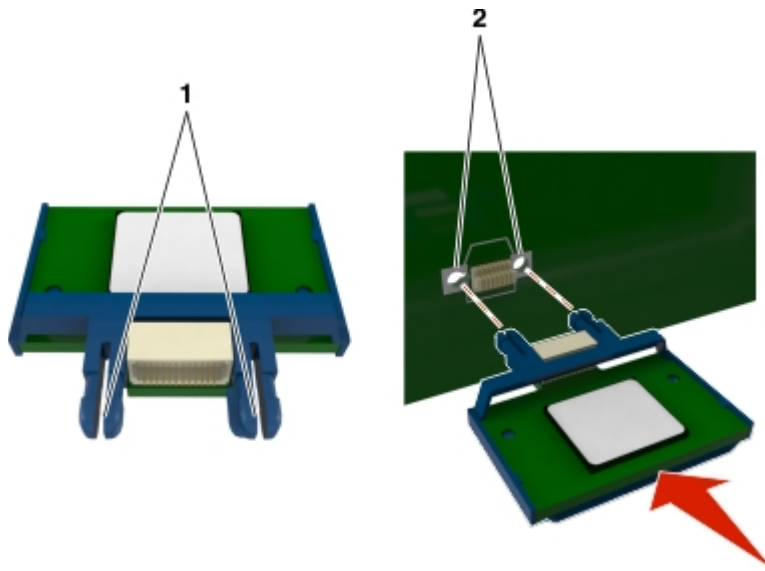

4. Push the card firmly into place as shown in the illustration.

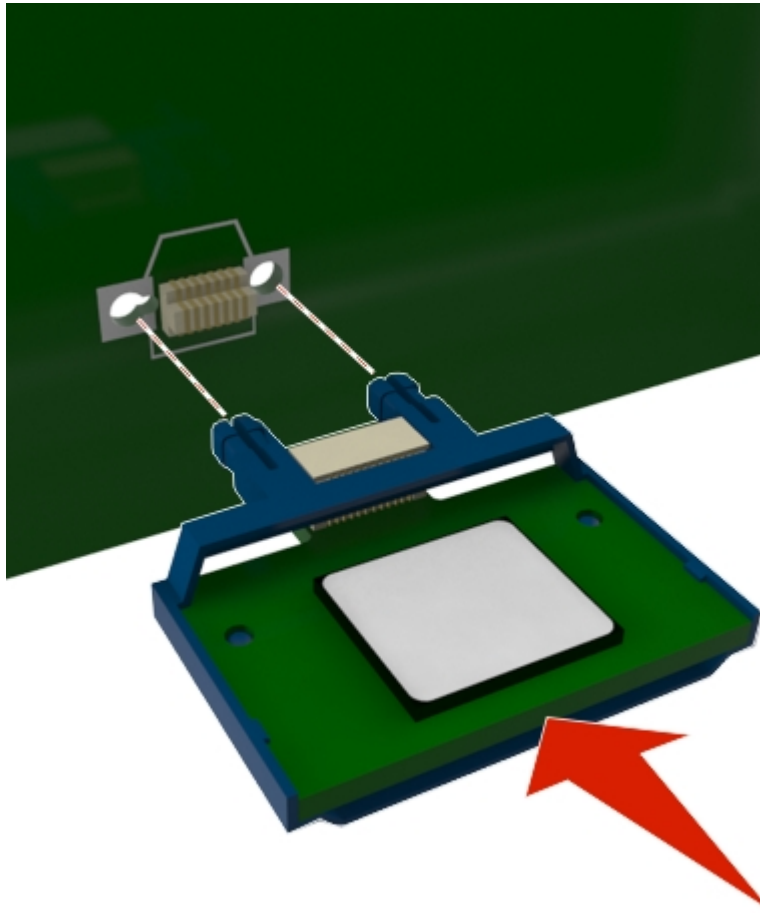

Warning—Potential Damage: Improper installation of the card may cause damage to the card and the controller board.

Note: The entire length of the connector on the card must touch and be flush against the controller board.

5. Close the controller board access door.

Note: When the printer software and any hardware options are installed, it may be necessary to manually add the options in the printer driver to make them available for print jobs. For more information, see [Adding available options in the printer driver](#).

Installing hardware options

Installing optional trays

⚠ CAUTION—SHOCK HAZARD: If you are accessing the controller board or installing optional hardware or memory devices sometime after setting up the printer, then turn the printer off, and unplug the power cord from the electrical outlet before continuing. If you have any other devices attached to the printer, then turn them off as well, and unplug any cables going into the printer.

1. Turn off the printer using the power switch, and then unplug the power cord from the electrical outlet.



2. Unpack the tray, and then remove any packing material.
3. Remove the tray from the base.

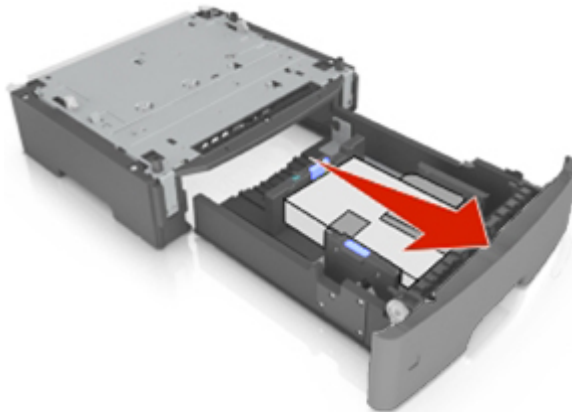

4. Remove any packing material from inside the tray.
5. Insert the tray into the base.
6. Place the tray near the printer.

- Align the printer with the tray, and then slowly lower the printer into place.

Note: Optional trays lock together when stacked.

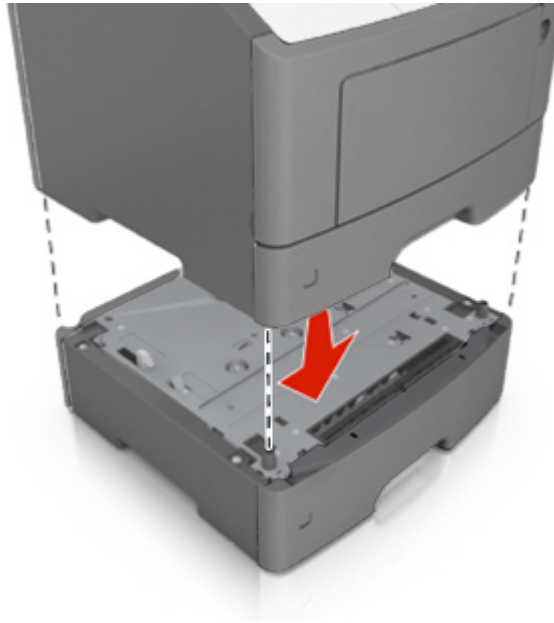

- Connect the power cord to the printer, then to a properly grounded electrical outlet, and then turn on the printer.



Note: When the printer software and any hardware options are installed, it may be necessary to manually add the options in the printer driver to make them available for print jobs. For more information, see [Adding available options in the printer driver](#).

To uninstall the optional trays, slide the latch on the right side of the printer toward the front of the printer until it *clicks* into place, and then remove stacked trays one at a time from the top to the bottom.

Attaching cables

Connect the printer to the computer using a USB or parallel cable, or to the network using an Ethernet cable.

Make sure to match the following:

- The USB symbol on the cable with the USB symbol on the printer
- The appropriate parallel cable with the parallel port
- The appropriate Ethernet cable with the Ethernet port

Warning—Potential Damage: Do not touch the USB cable, any network adapter, or the printer in the area shown while actively printing. Loss of data or a malfunction can occur.

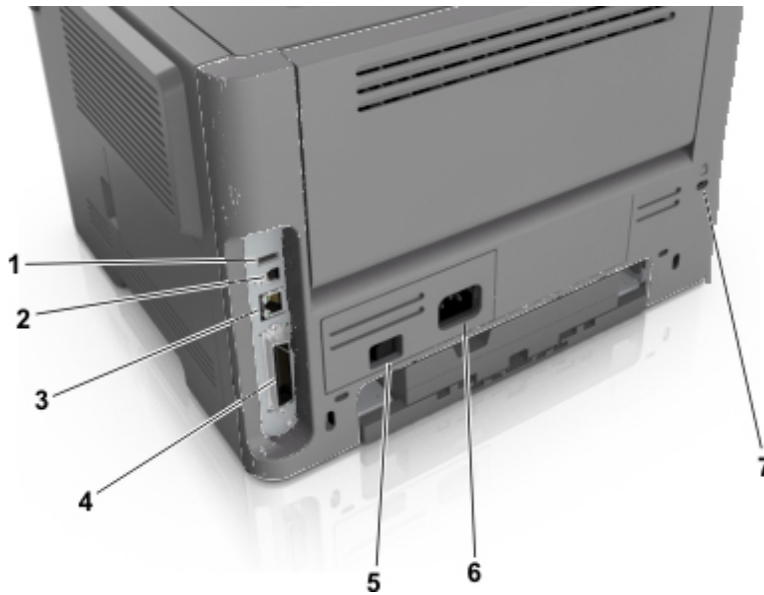

	Use the	To
1	USB port	Attach an optional wireless network adapter.
2	USB printer port	Connect the printer to a computer.
3	Ethernet port	Connect the printer to a network.
4	Parallel port	Connect the printer to a computer.
5	Power switch	Turn on or turn off the printer.
6	Printer power cord socket	Connect the printer to an electrical outlet.
7	Security slot	Attach a lock that will secure the printer in place.

Setting up the printer software

Installing the printer driver

1. Obtain a copy of the software installer package.
2. Run the installer, and then follow the instructions on the computer screen.
3. For Macintosh users, add the printer.

Note: Obtain the printer IP address from the TCP/IP section in the Network/Ports menu.

Adding available options in the printer driver

For Windows users

1. Open the printers folder.

In Windows 8

From the Search charm, type `run`, and then navigate to:

Run > type control printers >OK

In Windows 7 or earlier

- a. Click , or click **Start** and then click **Run**.
 - b. Type `control printers`.
 - c. Press **Enter**, or click **OK**.
2. Select the printer you want to update, and then do either of the following:
 - For Windows 7 or later, select **Printer properties**.
 - For earlier versions, select **Properties**.
 3. Navigate to the Configuration tab, and then select **Update Now - Ask Printer**.
 4. Apply the changes.

For Macintosh users

1. From System Preferences in the Apple menu, navigate to your printer, and then select **Options & Supplies**.
2. Navigate to the list of hardware options, and then add any installed options.
3. Apply the changes.

Networking

Notes:

- Purchase a wireless network adapter first before setting up the printer on a wireless network. For information on installing the wireless network adapter, see the instruction sheet that came with the adapter.
- A Service Set Identifier (SSID) is a name assigned to a wireless network. Wired Equivalent Privacy (WEP), Wi-Fi Protected Access (WPA), WPA2, and 802.1X - RADIUS are types of security used on a network.

Preparing to set up the printer on an Ethernet network

To configure your printer to connect to an Ethernet network, organize the following information before you begin:

Note: If your network automatically assigns IP addresses to computers and printers, continue on to installing the printer.

- A valid, unique IP address for the printer to use on the network
- The network gateway
- The network mask
- A nickname for the printer (optional)

Note: A printer nickname can make it easier for you to identify your printer on the network. You can choose to use the default printer nickname, or assign a name that is easier for you to remember.

You will need an Ethernet cable to connect the printer to the network and an available port where the printer can physically connect to the network. Use a new network cable when possible to avoid potential problems caused by a damaged cable.

Installing the printer on an Ethernet network

For Windows users

1. Insert the *Printer Driver and Documentations* CD in the CD/DVD drive of your PC.
2. Follow the instructions on the screen.
3. A device is detected and it is displayed on a device list. Choose a device to install and click **Next**.
4. Choose the component to install and click **Next**.
5. Installation was completed.

For Macintosh users

1. Allow the network DHCP server to assign an IP address to the printer.
2. Obtain the printer IP address either:
 - From the printer control panel
 - From the TCP/IP section in the Network/Ports menu
 - By printing a network setup page or menu settings page, and then finding the TCP/IP section

Note: You will need the IP address if you are configuring access for computers on a different subnet than the printer.
3. Install the printer driver on the computer.
 - a. Insert the *Printer Driver and Documentations* CD in the CD drive of your Macintosh.
 - b. Double-click the CD icon on the desktop, and then double-click the bizhub_4700PSeries_106.pkg in the english (other) folder.
 - c. The installer for the printer driver starts up.

Note:

The driver folder varies depending on the paper size.
Select the appropriate driver folder for your environment.

- To use inch-based paper size (8 1/2 x 11 in letter size): Select a file in the english folder.
- To use metric-based paper size (A4 and the like): Select a file in the other folder.

Note:

Double-click the package file appropriate for the application and version of operating system being used.

4. Add the printer.
 - a. (For Mac OS X v10.6)
Apple menu > **System preferences** > **Print & Fax** > +
(For Mac OS X v10.7/v10.8/v10.9/v10.10)
Apple menu > **System preferences** > **Print & Scan** > +
 - b. Select your printer.
 - c. Click **Add**.

For Linux users

Adding the Printer Using Printer configuration

1. Connect the machine to a computer or the network.

2. Insert the *Printer Driver and Documentations* CD in the CD/DVD drive of your computer.
3. From the System menu, select **Administration > Printing**.
4. Click **New Printer**.
5. Enter the Printer name, Description, and Location > **Forward**.
6. From the left pane of the dialog box, select the port for the machine to be installed.
7. Click **Forward**.
8. Select **Provide PPD file**.
9. Click the folder icon.
10. Select the PPD file.
11. Click **Open > Forward > Apply**.

Adding the Printer on the CUPS Administration Web page

1. Connect the machine to a computer or the network.
2. Start up the Web browser.
3. Enter the URL "http://localhost:631".
4. Click **Add Printer**.
5. Enter the Printer name, Location, and Description > **Continue**.
6. Select a Device Port from the Device list > **Continue**.
7. For a USB connection, skip to step 9.
Enter the device URI in the following form: "socket://<Printer IP or Printer Hostname>:port"
8. Click **Continue**.
9. Select **KONICA MINOLTA > Continue**.
10. Select **KONICA MINOLTA bizhub 4700P Series PPD (xx) > Add Printer**.
11. Enter the user name and password for using root privileges > **OK**.

Preparing to set up the printer on a wireless network

Notes:

- Make sure your wireless network adapter is installed in your printer and working properly. For more information, see the instruction sheet that came with the wireless network adapter.
- Make sure your access point (wireless router) is turned on and is working properly.

Make sure you have the following information before setting up the printer on a wireless network:

- **SSID**—The SSID is also referred to as the network name.
- **Wireless Mode (or Network Mode)**—The mode is either infrastructure or ad hoc.

- **Channel (for ad hoc networks)**—The channel defaults to automatic for infrastructure networks.

Some ad hoc networks will also require the automatic setting. Check with your system support person if you are not sure which channel to select.

- **Security Method**—There are four basic options for Security Method:

- WEP key

If your network uses more than one WEP key, then enter up to four in the provided spaces. Select the key currently in use on the network by selecting the default WEP transmit key.

- WPA or WPA2 preshared key or passphrase

WPA includes encryption as an additional layer of security. The choices are AES or TKIP. Encryption must be set for the same type on the router and on the printer, or the printer will not be able to communicate on the network.

- 802.1X–RADIUS

If you are installing the printer on an 802.1X network, then you may need the following:

- Authentication type
- Inner authentication type
- 802.1X user name and password
- Certificates

- No security

If your wireless network does not use any type of security, then you will not have any security information.

Note: We do not recommend using an unsecured wireless network.

Notes:

- If you do not know the SSID of the network that your computer is connected to, then launch the wireless utility of the computer network adapter, and then look for the network name. If you cannot find the SSID or the security information for your network, then see the documentation that came with the access point, or contact your system support person.
- To find the WPA/WPA2 preshared key or passphrase for the wireless network, see the documentation that came with the access point, see the Embedded Web Server associated with the access point, or consult your system support person.



Connecting the printer to a wireless network using Wi-Fi Protected Setup

Before connecting the printer to a wireless network, make sure that:

- The access point (wireless router) is Wi-Fi Protected Setup (WPS) certified or WPS-compatible. For more information, see the documentation that came with your access point.
- A wireless network adapter installed in your printer is attached and working properly. For more information, see the instruction sheet that came with the wireless network adapter.

Using the Push Button Configuration method





1. From the printer control panel, navigate to:

 >Network/Ports >  >Network [x] >  >Net [x] Setup >  >Wireless >  >
Wireless Connection Setup >  >Wi-Fi Protected Setup >  >Start Push Button Method
> 

2. Follow the instructions on the printer display.

Using the Personal Identification Number (PIN) method

1. From the printer control panel, navigate to:

 >Network/Ports >  >Network [x] >  >Net [x] Setup >  >Wireless >  >
Wireless Connection Setup >  >Wi-Fi Protected Setup >  >Start PIN Method > 

2. Copy the eight-digit WPS PIN.
3. Open a Web browser, and then type the IP address of your access point in the address field.

Notes:

- The IP address appears as four sets of numbers separated by periods, such as 123.123.123.123.
 - If you are using a proxy server, then temporarily disable it to load the Web page correctly.
4. Access the WPS settings. For more information, see the documentation that came with your access point.
 5. Enter the eight-digit PIN, and then save the setting.

Connecting the printer to a wireless network using the printer software

Notes:

- Make sure that the printer is turned on.
- Make sure that a wireless network adapter is installed in your printer and working properly. For information, see the instruction sheet that came with the adapter.

Using the Wireless Setup Utility (Windows only)

The Wireless Setup Utility lets you:

- Configure the printer to join an existing wireless network.
- Add a printer to an existing ad hoc network.
- Change the wireless settings after installation.
- Install the printer on additional network computers.

For the Wireless Setup Utility download, please refer to the URL described on the *Printer Driver and Documentations CD*.

Using the Wireless Setup Assistant (Macintosh only)

The Wireless Setup Assistant lets you:

- Configure the printer to join an existing wireless network.
- Add a printer to an existing ad hoc network.
- Change the wireless settings after installation.
- Install the printer on additional network computers.

Installing the Wireless Setup Assistant

1. Download the latest Wireless Setup Assistant application.
 - For the download, please refer to the URL described on the *Printer Driver and Documentations CD*.
2. Double-click the downloaded software installer package.
3. Follow the instructions on the computer screen.

Launching the Wireless Setup Assistant

Notes:

- Make sure the printer is turned on.
 - Make sure a wireless network adapter is installed in your printer and is working properly.
1. From the Finder, navigate to:
 - Applications** > select your printer folder
 2. Double-click **Wireless Setup Assistant**, and then follow the instructions on the computer screen.

Connecting the printer to a wireless network using the Embedded Web Server

Before you begin, make sure that:

- Your printer is connected temporarily to an Ethernet network.
 - A wireless network adapter is installed in your printer and working properly. For more information, see the instruction sheet that came with your wireless network adapter.
1. Open a Web browser, and then type the printer IP address in the address field.

Notes:

- View the printer IP address on the printer control panel. The IP address appears as four sets of numbers separated by periods, such as 123.123.123.123.
- If you are using a proxy server, then temporarily disable it to load the Web page correctly.

2. Click **Settings >Network/Ports >Wireless**.
3. Modify the settings to match the settings of your access point (wireless router).
Note: Make sure to enter the correct SSID.
4. Click **Submit**.
5. Turn off the printer, and then disconnect the Ethernet cable. Then wait for at least five seconds, and then turn the printer back on.
6. To verify if your printer is connected to the network, print a network setup page. Then in the Network Card [x] section, see if the status is Connected.

Printing menu settings and network setup pages

Printing a menu settings page

Print a menu settings page to review the current menu settings and to verify if the printer options are installed correctly.

Note: If you have not changed any menu settings, then the menu settings page lists all the factory default settings. When you select and save other settings from the menus, they replace the factory default settings as *user default settings*. A user default setting remains in effect until you access the menu again, choose another value, and save it.

From the printer control panel, navigate to:



Printing a network setup page

If the printer is connected to a network, then print a network setup page to verify the network connection. This page also provides important information that aids network printing configuration.

1. From the printer control panel, navigate to:



Note: If an optional print server is installed, then **Print Network [x] Setup Page** appears.

2. Check the first section of the network setup page and confirm that the status is Connected.

If the status is Not Connected, then the LAN drop may not be active, or the network cable may be malfunctioning. Consult your system support person for a solution, and then print another network setup page.

4— Using the printer control panel

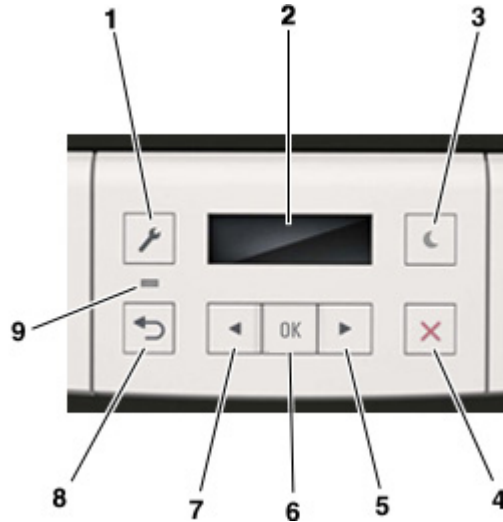

	Use the	To
1	Menu button	<p>Open the menus.</p> <p>Notes:</p> <ul style="list-style-type: none"> • The menus are available only when the printer is in the Ready state. • Pressing the button while navigating within the menus returns the printer control panel to the top-level menu screen.
2	Display	View printing options as well as status and error messages.
3	Sleep button	<p>Enable Sleep mode or Hibernate mode.</p> <p>Notes:</p> <ul style="list-style-type: none"> • Pressing any hard button will cause the printer to wake from Sleep mode. • Pressing the Sleep button or the power switch will cause the printer to wake from Hibernate mode.
4	Stop button	<ul style="list-style-type: none"> • Exit the menus and return to the Ready state. • Stop printer activities, such as printing or downloading fonts.
5	Right arrow button	<ul style="list-style-type: none"> • Scroll through menus or to move between screens and menu options. • Scroll through settings or text. For menus with numeric values, press and hold an arrow button to scroll through the settings. Release the button when the value you want appears.

	Use the	To
6	Select button	<ul style="list-style-type: none"> • Open a menu. • Display available values or settings for a menu. The current default setting is indicated by an asterisk (*). • Save the displayed value as the new user default setting.
7	Left arrow button	<ul style="list-style-type: none"> • Scroll through menus or to move between screens and menu options. • Scroll through settings or text. For menus with numeric values, press and hold an arrow button to scroll through the settings. Release the button when the value you want appears.
8	Back button	Return to the previous screen.
9	Indicator light	Determine the status of the printer.

Understanding the colors of the Sleep button and indicator lights

The colors of the Sleep button and indicator lights on the control panel signify a printer status or condition.

Indicator light	Printer status
Off	The printer is off or in Hibernate mode.
Blinking green	The printer is warming up, processing data, or printing.
Solid green	The printer is on, but idle.
Blinking red	The printer requires user intervention.

Sleep button light	Printer status
Off	The printer is off, idle, or in Ready state.
Solid amber	The printer is in Sleep mode.
Blinking amber	The printer is entering or waking from Hibernate mode.

Sleep button light	Printer status
Blinking amber for 0.1 second, then goes completely off for 1.9 seconds in a slow, pulsing pattern	The printer is in Hibernate mode.

Installing the Local Printer Settings Utility

1. Download the software.
 - For the download, please refer to the URL described on the *Printer Driver and Documentations* CD.
2. Double-click the software installer package.
3. Select an installation type, and then click **Install**.
4. Click **Install** to start the installation.
5. Click **Agree** to accept the license agreement.
6. Click **Continue**, and then follow the instructions on the computer screen.

Notes:

- Use the Local Printer Settings Utility to change the toner darkness, power saver, and paper size settings for all print jobs. Use the printer software to change these settings for individual print jobs.
- This utility is supported only in select printer models.

Using the Local Printer Settings Utility

1. Access the Local Printer Settings Utility from the list of applications or the Start menu to adjust the printer settings.
2. Save the changes using the Actions menu.

Note: To distribute the settings to other printers, save the settings in a command file.

5—Loading paper and specialty media

Setting the paper size and type

1. From the printer control panel, navigate to:



2. Select **Tray [x] Size** or **Tray [x] Type**, and then press .

3. Change the paper size or type setting, and then press .

Notes:

- The paper size setting for the standard 250-sheet tray (Tray 1), optional 250- or 550-sheet tray (Tray 2), and the multipurpose feeder must be set manually in the Paper Size menu.
- The factory default paper type for Tray 1 is Plain Paper.
- The factory default paper type for the multipurpose feeder is Custom Type 6.
- The paper type setting must be manually set for all trays.

Configuring Universal paper settings

The Universal paper size is a user-defined setting that lets you print on paper sizes that are not preset in the printer menus.

Notes:

- The smallest Universal paper size is 76.2 x 127 mm (3 x 5 inches), and is supported only from the multipurpose feeder.
- The largest Universal paper size is 215.9 x 355.6 mm (8.5 x 14 inches), and is supported from all paper sources.

From the control panel, navigate to:

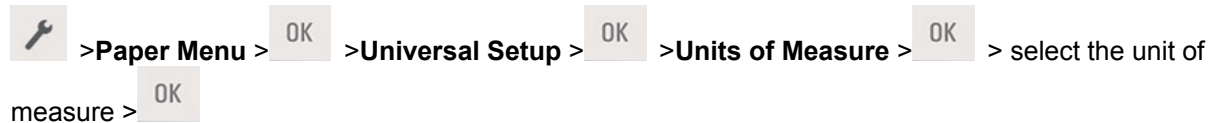

Specify the paper height and width

1. From the control panel, navigate to:



2. Press the arrow buttons until **Portrait Height** or **Portrait Width** appears, and then press

OK

3. Change the settings, and then press

OK

Using the standard bin and paper stop

The standard bin holds up to 150 sheets of 75-g/m² (20-lb) paper. It collects prints facedown. The standard bin includes a paper stop that keeps paper from sliding out the front of the bin as it stacks.

To open the paper stop, pull it so that it flips forward.



Note: Close the paper stop when moving the printer to another location.

Loading trays

⚠ CAUTION—POTENTIAL INJURY: To reduce the risk of equipment instability, load each tray separately. Keep all other trays closed until needed.

1. Pull out the tray completely.

Note: Do not remove trays while a job prints or while **Busy** appears on the printer display. Doing so may cause a jam.



2. Squeeze and then slide the width guide tab to the correct position for the size of the paper you are loading.

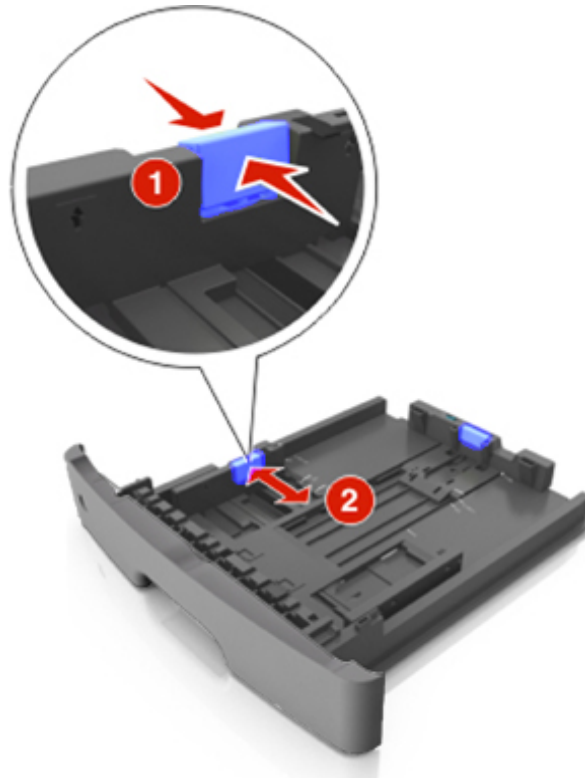

3. Squeeze and then slide the length guide tab to the correct position for the size of the paper you are loading.

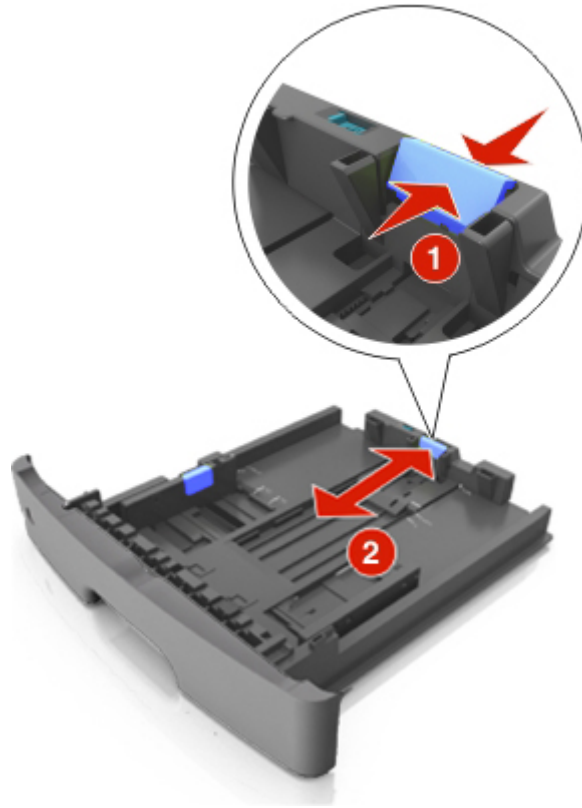

Notes:

- For some paper sizes like letter, legal, and A4, squeeze and slide the length guide tab backward to accommodate their length.
- When loading legal-size paper, the length guide extends beyond the base leaving the paper exposed to dust. To protect the paper from dust, you can purchase a dust cover separately.
- If you are loading A6-size paper in the standard tray, then squeeze and then slide the length guide tab toward the center of the tray to the A6-size position.
- Make sure the width and length guides are aligned with the paper size indicators on the bottom of the tray.

User's Guide



4. Flex the sheets back and forth to loosen them, and then fan them. Do not fold or crease the paper. Straighten the edges on a level surface.



5. Load the paper stack.



Notes:

- Load with the printable side facedown when using recycled or preprinted paper.

User's Guide

- Load prepunched paper with the holes on the top edge toward the front of the tray.
- Load letterhead facedown, with the top edge of the sheet toward the front of the tray. For two-sided printing, load letterhead faceup with the bottom edge of the sheet toward the front of the tray.
- Make sure the paper is below the maximum paper fill indicator located on the side of the width guide.

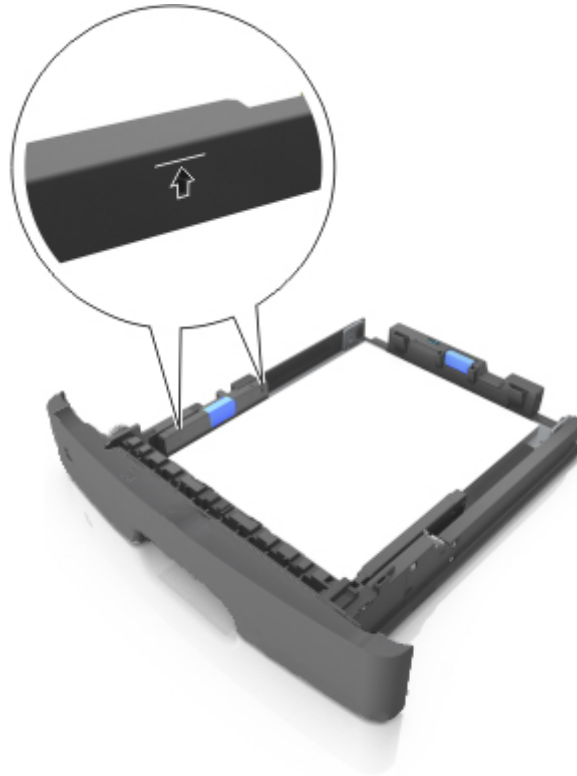

6. Insert the tray.



7. From the printer control panel, set the paper size and paper type in the Paper menu to match the paper loaded in the tray.

Note: Set the correct paper size and type to avoid paper jams and print quality problems.

Loading the multipurpose feeder

Use the multipurpose feeder when printing on different paper sizes and types or specialty media, such as card stock, transparencies, paper labels, and envelopes. You can also use it for single-page print jobs on letterhead.

1. Open the multipurpose feeder.



- a. Pull the multipurpose feeder extender.

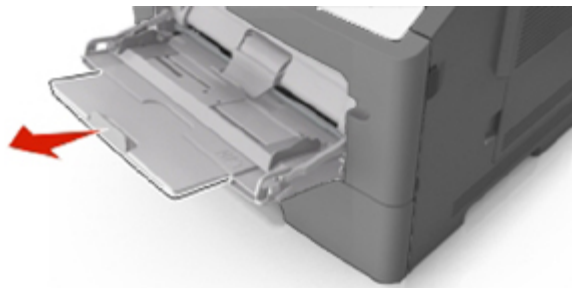

- b. Pull the extender gently so that the multipurpose feeder is fully extended and open.

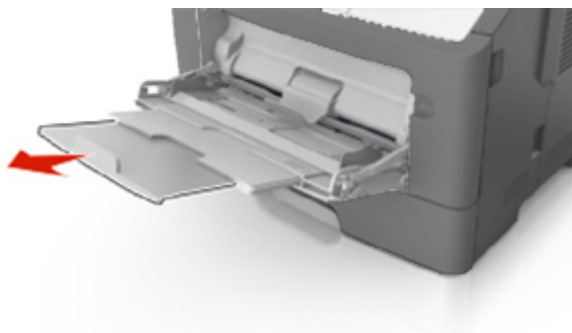

2. Squeeze the tab on the left width guide, and then move the guides for the paper you are loading.



3. Prepare the paper or specialty media for loading.

- Flex sheets of paper back and forth to loosen them, and then fan them. Do not fold or crease the paper. Straighten the edges on a level surface.



- Hold transparencies by the edges. Flex the stack of transparencies back and forth to loosen them, and then fan them. Straighten the edges on a level surface.

Note: Avoid touching the printable side of the transparencies. Be careful not to scratch them.



- Flex the stack of envelopes back and forth to loosen them, and then fan them. Straighten the edges on a level surface.



4. Load the paper or specialty media.

Notes:

- Do not force paper or specialty media into the multipurpose feeder.
- Make sure the paper or specialty media is below the maximum paper fill indicator located on the paper guides. Overfilling may cause paper jams.

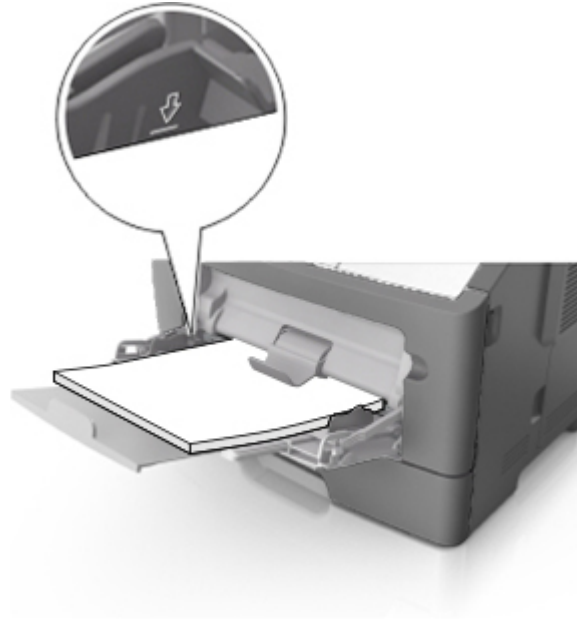

- Load paper, transparencies, and card stock with the recommended printable side faceup and the top edge entering the printer first. For more information on loading transparencies, see the packaging that the transparencies came in.

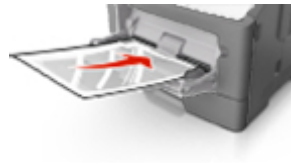
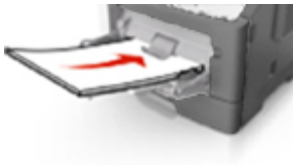

Note: When loading A6-size paper, make sure the multipurpose feeder extender rests lightly against the edge of the paper so that the last few sheets of paper remain in place.

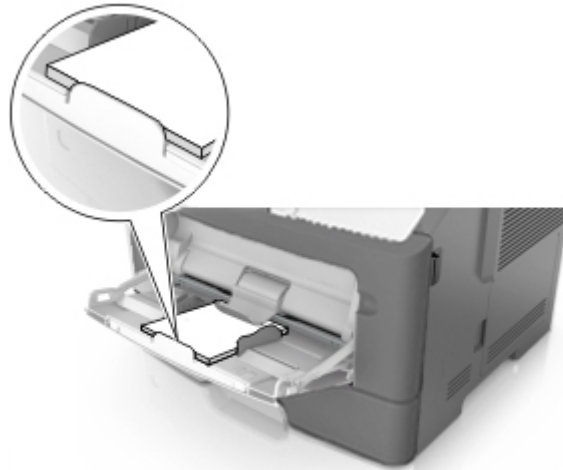

- Load letterhead faceup with the top edge entering the printer first. For two-sided (duplex) printing, load letterhead facedown with the bottom edge entering the printer first.



- Load envelopes with the flap on the left side facedown.

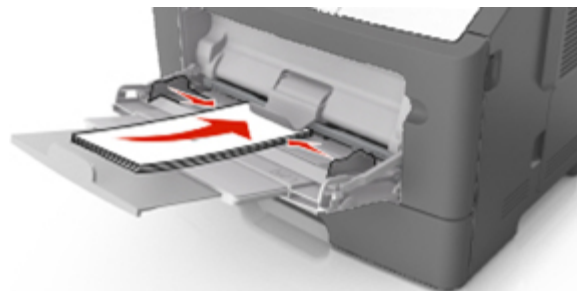

Warning—Potential Damage: Never use envelopes with stamps, clasps, snaps, windows, coated linings, or self-stick adhesives. These envelopes may severely damage the printer.

5. From the printer control panel, set the paper size and paper type in the Paper menu to match the paper or specialty media loaded in the multipurpose feeder.

Linking and unlinking trays

The printer links trays when the specified paper size and type are the same. When a linked tray becomes empty, paper feeds from the next linked tray. To prevent trays from linking, assign a unique custom paper type name.

Linking and unlinking trays

Using the Embedded Web Server

1. Open a Web browser, and then type the printer IP address in the address field.

Notes:

- View the printer IP address in the TCP/IP section in the Network/Ports menu. The IP address appears as four sets of numbers separated by periods, such as 123.123.123.123.
 - If you are using a proxy server, then temporarily disable it to load the Web page correctly.
2. Click **Settings > Paper Menu**.
 3. Change the tray settings to specify the paper size and type for the tray.
 - To link trays, make sure the paper size and type for the tray match with that of the other tray.
 - To unlink trays, make sure the paper size or type for the tray does *not* match with that of the other tray.
 4. Click **Submit**.

Using the printer settings on the computer

Depending on your operating system, access the Paper menu using the Local Printer Settings Utility or Printer Settings.

Note: You can also specify the paper size and type for the tray using the printer control panel. For more information, see [Setting the paper size and type](#).

Warning—Potential Damage: Paper loaded in the tray should match the paper type name assigned in the printer. The temperature of the fuser varies according to the specified paper type. Printing issues may occur if settings are not properly configured.

Configuring a custom paper type

Using the Embedded Web Server

1. Open a Web browser, and then type the printer IP address in the address field.

Notes:

- Print a network setup page or menu settings page, and then locate the IP address in TCP/IP section. The IP address appears as four sets of numbers separated by periods, such as 123.123.123.123.
- If you are using a proxy server, then temporarily disable it to load the Web page correctly.

2. Click **Settings >Paper Menu >Custom Types**.
3. Select a custom paper type name, and then select a custom paper type.

Note: Plain Paper is the factory default paper type for all user-defined custom names.

4. Click **Submit**.

Using the printer settings on the computer

Depending on your operating system, access the Custom menu using the Local Printer Settings Utility or Printer Settings.

Assigning a custom paper type

Using the Embedded Web Server

1. Open a Web browser, and then type the printer IP address in the address field.

Notes:

- Print a network setup page or menu settings page, and then locate the IP address in the TCP/IP section. The IP address appears as four sets of numbers separated by periods, such as 123.123.123.123.
- If you are using a proxy server, then temporarily disable it to load the Web page correctly.

2. Click **Settings >Paper Menu**.
3. From the Tray Configuration section, select a paper source, and then select a custom paper type under the paper type column.
4. Click **Submit**.

Using the printer settings on the computer

Depending on your operating system, access the Paper menu using the Local Printer Settings Utility or Printer Settings.

6—Paper and specialty media guide

Paper guidelines

Paper characteristics

The following paper characteristics affect print quality and reliability. Consider these characteristics when evaluating new paper stock.

Weight

The printer trays can automatically feed paper weights up to 90-g/m² (24-lb) bond grain long paper. The multipurpose feeder can automatically feed paper weights up to 163-g/m² (43-lb) bond grain long paper. Paper lighter than 60 g/m² (16 lb) might not be stiff enough to feed properly, causing jams. For best performance, use 75-g/m² (20-lb) bond grain long paper. For paper smaller than 182 x 257 mm (7.2 x 10.1 inches), we recommended to use 90 g/m² (24 lb) or heavier paper.

Note: Two-sided printing is supported only for 60–90-g/m² (16–24-lb) bond paper.

Curl

Curl is the tendency for paper to curl at its edges. Excessive curl can cause paper feeding problems. Curl can occur after the paper passes through the printer, where it is exposed to high temperatures. Storing paper unwrapped in hot, humid, cold, or dry conditions, even in the trays, can contribute to paper curling prior to printing and can cause feeding problems.

Smoothness

Paper smoothness directly affects print quality. If paper is too rough, then toner cannot fuse to it properly. If paper is too smooth, then it can cause paper feeding or print quality issues. Always use paper between 100 and 300 Sheffield points; however, smoothness between 150 and 250 Sheffield points produces the best print quality.

Moisture content

The amount of moisture in paper affects both print quality and the ability of the printer to feed the paper correctly. Leave paper in its original wrapper until it is time to use it. This limits the exposure of paper to moisture changes that can degrade its performance.

Store paper in its original wrapper in the same environment as the printer for 24 to 48 hours before printing. Extend the time to several days if the storage or transportation environment is very different from the printer environment. Thick paper may also require a longer conditioning period.

Grain direction

Grain refers to the alignment of the paper fibers in a sheet of paper. Grain is either *grain long*, running the length of the paper, or *grain short*, running the width of the paper.

For 60–90-g/m² (16–24-lb) bond paper, grain long paper is recommended.

Fiber content

Most high-quality xerographic paper is made from 100% chemically treated pulped wood. This content provides the paper with a high degree of stability resulting in fewer paper feeding problems and better print quality. Paper containing fibers such as cotton can negatively affect paper handling.

Unacceptable paper

The following paper types are not recommended for use with the printer:

- Chemically treated papers used to make copies without carbon paper, also known as carbonless papers, carbonless copy paper (CCP), or no carbon required (NCR) paper
- Preprinted papers with chemicals that may contaminate the printer
- Preprinted papers that can be affected by the temperature in the printer fuser
- Preprinted papers that require a registration (the precise print location on the page) less than ±2.5 mm (±0.10 inch), such as optical character recognition (OCR) forms

In some cases, registration can be adjusted with a software application to successfully print on these forms:

- Coated papers (erasable bond), synthetic papers, thermal papers
- Rough-edged, rough or heavily textured surface papers, or curled papers
- Recycled papers that fail EN12281:2002 (European)
- Paper weighing less than 60 g/m² (16 lb)
- Multiple-part forms or documents

Selecting paper

Using the appropriate paper prevents jams and helps ensure trouble-free printing.

To help avoid paper jams and poor print quality:

- *Always* use new, undamaged paper.
- Before loading paper, know the recommended printable side of the paper. This information is usually indicated on the paper package.
- *Do not* use paper that has been cut or trimmed by hand.
- *Do not* mix paper sizes, types, or weights in the same tray; mixing results in jams.
- *Do not* use coated papers unless they are specifically designed for electrophotographic printing.

Selecting preprinted forms and letterhead

Use these guidelines when selecting preprinted forms and letterhead:

- Use grain long for 60 to 90 g/m² (16 to 24 lb) weight paper.
- Use only forms and letterhead printed using an offset lithographic or engraved printing process.
- Avoid papers with rough or heavily textured surfaces.

Use papers printed with heat-resistant inks designed for use in xerographic copiers. The ink must be able to withstand temperatures up to 230°C (446°F) without melting or releasing hazardous emissions. Use inks that are not affected by the resin in toner. Inks that are oxidation-set or oil-based generally meet these requirements; latex inks might not. When in doubt, contact the paper supplier.

Preprinted papers such as letterhead must be able to withstand temperatures up to 230°C (446°F) without melting or releasing hazardous emissions.

Unacceptable paper examples

Test results indicate that the following paper types are at risk for use with laser printers:

- Chemically treated papers used to make copies without carbon paper, also known as *carbonless papers*
- Preprinted papers with chemicals that may contaminate the printer
- Preprinted papers that can be affected by the temperature in the printer fuser
- Preprinted papers that require a registration (the precise location on the page) greater than ± 2.3 mm (± 0.9 in.), such as optical character recognition (OCR) forms. In some cases, registration can be adjusted with a software application to successfully print on these forms.)
- Coated papers (erasable bond), synthetic papers, thermal papers
- Rough-edged, rough or heavily textured surface papers or curled papers
- Recycled papers that fail EN12281:2002 (European testing)
- Paper weighing less than 60 g/m² (16 lb)
- Multiple part forms or documents

Storing paper

Use these paper storage guidelines to help avoid jams and uneven print quality:

- For best results, store paper where the temperature is 21°C (70°F) and the relative humidity is 40 percent. Most label manufacturers recommend printing in a temperature range of 18–24°C (65–75°F) with relative humidity between 40 and 60 percent.
- Store paper in cartons, on a pallet or shelf, rather than on the floor.
- Store individual packages on a flat surface.

- Do not store anything on top of individual paper packages.
- Take paper out of the carton or wrapper only when you are ready to load it in the printer. The carton and wrapper help keep the paper clean, dry, and flat.

Using specialty media

Tips on using card stock

Card stock is heavy, single-ply specialty media. Many of its variable characteristics, such as moisture content, thickness, and texture, can significantly impact print quality. Print samples on the card stock being considered for use before buying large quantities.

When printing on card stock:

- Make sure the Paper Type is Card Stock.
- Select the appropriate Paper Texture setting.
- Be aware that preprinting, perforation, and creasing may significantly affect the print quality and cause jams or other paper handling problems.
- Check with the manufacturer or vendor to ensure that the card stock can withstand temperatures up to 240°C (464°F) without releasing hazardous emissions.
- Do not use preprinted card stock manufactured with chemicals that may contaminate the printer. Preprinting introduces semi-liquid and volatile components into the printer.
- Use grain short card stock when possible.

Tips on using envelopes

Print samples on the envelopes being considered for use before buying large quantities.

- Use envelopes designed specifically for laser printers. Check with the manufacturer or vendor to ensure that the envelopes can withstand temperatures up to 230°C (446°F) without sealing, wrinkling, curling excessively, or releasing hazardous emissions.
- For best performance, use envelopes made from 90-g/m² (24-lb bond) paper or 25% cotton. All-cotton envelopes must not exceed 70-g/m² (20-lb bond) weight.
- Use only new envelopes from undamaged packages.
- To optimize performance and minimize jams, do not use envelopes that:
 - Have excessive curl or twist
 - Are stuck together or damaged in any way
 - Have windows, holes, perforations, cutouts, or embossing
 - Have metal clasps, string ties, or folding bars
 - Have an interlocking design

- Have postage stamps attached
 - Have any exposed adhesive when the flap is in the sealed or closed position
 - Have bent corners
 - Have rough, cockle, or laid finishes
 - Adjust the width guides to fit the width of the envelopes.
- Note:** A combination of high humidity (over 60%) and high printing temperature may wrinkle or seal envelopes.

Tips on using labels

Print samples on the labels being considered for use before buying large quantities.

Note: Use only paper label sheets. Vinyl, pharmacy, and two-sided labels are not supported.

When printing on labels:

- Use labels designed specifically for laser printers. Check with the manufacturer or vendor to verify that:
 - The labels can withstand temperatures up to 240°C (464°F) without sealing, excessive curling, wrinkling, or releasing hazardous emissions.
 - Label adhesives, face sheet (printable stock), and topcoats can withstand up to 172-kPa (25-psi) pressure without delaminating, oozing around the edges, or releasing hazardous fumes.
- Do not use labels with slick backing material.
- Use full label sheets. Partial sheets may cause labels to peel off during printing, resulting in a jam. Partial sheets also contaminate the printer and the cartridge with adhesive, and could void the printer and toner cartridge warranties.
- Do not use labels with exposed adhesive.
- Do not print within 1 mm (0.04 inch) of the edge of the label, of the perforations, or between die-cuts of the label.
- Make sure the adhesive backing does not reach to the edge of the sheet. Zone coating of the adhesive should be at least 1 mm (0.04 inch) away from edges. Adhesive material contaminates the printer and could void the warranty.
- If zone coating of the adhesive is not possible, then remove a 2-mm (0.08-inch) strip on the leading and driver edge, and then use a non-oozing adhesive.
- Portrait orientation is recommended, especially when printing bar codes.

Tips on using letterhead

- Use letterhead designed specifically for laser printers.
- Print samples on the letterhead being considered for use before buying large quantities.

- Before loading letterhead, flex, fan, and straighten the stack to prevent sheets from sticking together.
- Page orientation is important when printing on letterhead. For information on how to load letterhead, see:
 - [Loading trays](#)
 - [Loading the multipurpose feeder](#)

Tips on using transparencies

- Print a test page on the transparencies being considered for use before buying large quantities.
- Feed transparencies from the standard tray, or the multipurpose feeder.
- Use transparencies designed specifically for laser printers. Transparencies must be able to withstand temperatures up to 185°C (365°F) without melting, discoloring, offsetting, or releasing hazardous emissions.

Note: If the transparency weight is set to Heavy and the transparency texture is set to Rough in the Paper menu, then transparencies can be printed at a temperature up to 195°C (383°F).

- Avoid getting fingerprints on the transparencies to prevent print quality problems.
- Before loading transparencies, flex, fan, and straighten the stack to prevent sheets from sticking together.

Supported paper sizes, types, and weights

For information on card stock and labels, see the *Card Stock & Label Guide*.

Supported paper sizes

Paper size	Standard tray	Optional 250- or 550-sheet tray	Multipurpose feeder	Duplex mode
A4 210 x 297 mm (8.3 x 11.7 in.)	✓	✓	✓	✓
A5 148 x 210 mm (5.8 x 8.3 in.)	✓	✓ ³	✓	X
A6 105 x 148 mm (4.1 x 5.8 in.)	✓	✓	✓	X
JIS B5 182 x 257 mm (7.2 x 10.1 in.)	✓	✓	✓	X

User's Guide

Paper size	Standard tray	Optional 250- or 550-sheet tray	Multipurpose feeder	Duplex mode
Letter 216 x 279 mm (8.5 x 11 in.)	✓	✓	✓	✓
Legal 216 x 356 mm (8.5 x 14 in.)	✓	✓	✓	✓
Executive 184 x 267 mm (7.3 x 10.5 in.)	✓	✓	✓	X
Oficio (Mexico) 216 x 340 mm (8.5 x 13.4 in.)	✓	✓	✓	✓
Folio 216 x 330 mm (8.5 x 13 in.)	✓	✓	✓	✓
Statement 140 x 216 mm (5.5 x 8.5 in.)	✓	✓	✓	X
Universal ^{1, 2} 76.2 x 127 mm (3 x 5 in.) up to 216 x 356 mm (8.5 x 14 in.)	✓	✓	✓	✓
7 3/4 Envelope (Monarch) 98 x 191 mm (3.9 x 7.5 in.)	X	X	✓	X
9 Envelope 98 x 225 mm (3.9 x 8.9 in.)	X	X	✓	X
10 Envelope 105 x 241 mm (4.1 x 9.5 in.)	X	X	✓	X
DL Envelope 110 x 220 mm (4.3 x 8.7 in.)	X	X	✓	X
C5 Envelope 162 x 229 mm (6.4 x 9 in.)	X	X	✓	X

Paper size	Standard tray	Optional 250- or 550-sheet tray	Multipurpose feeder	Duplex mode
B5 Envelope 176 x 250 mm (6.9 x 9.8 in.)	X	X	✓	X
Other Envelope 229 x 356 mm (9 x 14 in.)	X	X	✓	X
<p>¹ This size setting formats the page for 216 x 356 mm (8.5 x 14 in.) unless the size is specified by the software application.</p> <p>² Universal is supported in the standard tray only if the paper size is at least 105 x 148 mm (4.1 x 5.8 in.). Universal is supported in the optional 250- or 550-sheet tray only if the paper size is at least 148 x 210 mm (5.8 x 8.3 in.). Universal is supported in duplex mode only if the width is at least 210 mm (8.3 in.) and the length is at least 279 mm (11 in.). The smallest supported Universal size is supported only in the multipurpose feeder.</p> <p>³ Only long edge feeding is non-supported.</p>				

Supported paper types and weights

The standard tray supports 60–90-g/m² (16–24-lb) paper weights. The optional tray supports 60–120-g/m² (16–32-lb) paper weights. The multipurpose feeder supports 60–163-g/m² (16–43-lb) paper weights.

Paper type	250- or 550-sheet tray	Multipurpose feeder	Duplex mode
Plain paper	✓	✓	✓
Card stock	X	✓	X
Transparencies	✓	✓	X
Recycled	✓	✓	✓
Glossy paper	X	X	X
Paper labels¹	✓	✓	✓
Vinyl labels	X	X	X
Bond²	✓	✓	✓
Envelope	X	✓	X

User's Guide

Paper type	250- or 550-sheet tray	Multipurpose feeder	Duplex mode
Rough envelope	X	✓	X
Letterhead	✓	✓	✓
Preprinted	✓	✓	✓
Colored Paper	✓	✓	✓
Light Paper	✓	✓	✓
Heavy Paper²	✓	✓	✓
Rough/Cotton	X	X	X

¹ One-sided paper labels designed for laser printers are supported for occasional use. It is recommended to print 20 or fewer pages of paper labels per month. Vinyl, pharmacy, and two-sided labels are not supported.

² Bond and Heavy Paper are supported in duplex mode up to 90-g/m² (24-lb) paper weight.

7—Printing

Printing a document

Printing a document

1. From the Paper menu on the printer control panel, set the paper type and size to match the paper loaded.
2. Send the print job:

For Windows users

- a. With a document open, click **File >Print**.
- b. Click **Properties, Preferences, Options, or Setup**.
- c. Adjust the settings, if necessary.
- d. Click **OK >Print**.

For Macintosh users

- a. Customize the settings in the Page Setup dialog:
 1. With a document open, choose **File >Page Setup**.
 2. Choose a paper size or create a custom size to match the paper loaded.
 3. Click **OK**.
- b. Customize the settings in the Print dialog:
 1. With a document open, choose **File >Print**.
If necessary, click the disclosure triangle to see more options.
 2. From the Print dialog and pop-up menus, adjust the settings if necessary.
Note: To print on a specific paper type, adjust the paper type setting to match the paper loaded, or select the appropriate tray or feeder.
 3. Click **Print**.

Adjusting toner darkness

Using the Embedded Web Server

1. Open a Web browser, and then type the printer IP address in the address field.

Notes:

- View the printer IP address in the TCP/IP section in the Network/Ports menu. The IP address appears as four sets of numbers separated by periods, such as 123.123.123.123.

- If you are using a proxy server, then temporarily disable it to load the Web page correctly.
- 2. Click **Settings >Print Settings >Quality Menu >Toner Darkness**.
- 3. Adjust the toner darkness setting.
- 4. Click **Submit**.

Using the printer settings on the computer

Depending on your operating system, adjust the toner darkness settings using the Local Printer Settings Utility or Printer Settings.

Using the printer control panel

1. From the printer control panel, navigate to:

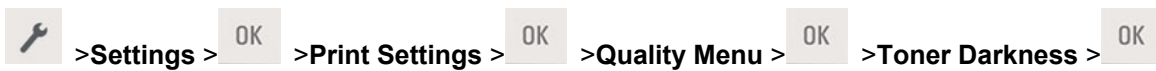

2. Adjust the toner darkness.
3. Press .

Printing information pages

For information on printing a menu settings page or a network setup page, see [Printing a menu settings page](#) and [Printing a network setup page](#).

Printing a font sample list

From the printer control panel, navigate to either of the following:





or



Canceling a print job

Canceling a print job from the printer control panel

From the printer control panel, press  > .

Canceling a print job from the computer

For Windows users

1. Open the printers folder, and then select your printer.
2. From the print queue, select the print job you want to cancel, and then delete it.

For Macintosh users

1. From System Preferences in the Apple menu, navigate to your printer.
2. From the print queue, select the print job you want to cancel, and then delete it.

8—Saving the environment

Saving paper and toner

Studies show that as much as 80% of the carbon footprint of a printer is related to paper usage. You can significantly reduce your carbon footprint by using recycled paper and the following printing suggestions, such as printing on both sides of the paper and printing multiple pages on one side of a single sheet of paper.

For information on how you can quickly save paper and energy using one printer setting, see [Using Eco-Mode](#).

Using recycled paper

As an environmentally conscious company, KONICA MINOLTA supports the use of recycled office paper produced specifically for use in laser printers.

Conserving supplies

Use both sides of the paper

If your printer model supports two-sided printing, then you can control whether print appears on one or two sides of the paper.

Note: Two-sided printing is the default setting in the printer driver.

Place multiple pages on one sheet of paper

You can print up to 16 consecutive pages of a multiple-page document onto one side of a single sheet of paper by setting multiple page printing (N-Up) for the print job.

Avoid paper jams

Correctly set the paper type and size to avoid paper jams. For more information, see [Avoiding jams](#).

9—Managing the printer

Finding advanced networking and administrator information

This chapter covers basic administrative support tasks using the Embedded Web Server. For more advanced system support tasks, see the *Networking Guide* on the *Printer Driver and Documentations CD*.

Copying printer settings to other printers

Note: This feature is available only in network printers.

1. Open a Web browser, and then type the printer IP address in the address field.

Notes:

- View the printer IP address in the TCP/IP section in the Network/Ports menu. The IP address appears as four sets of numbers separated by periods, such as 123.123.123.123.
- If you are using a proxy server, then temporarily disable it to load the Web page correctly.

2. Click the **Copy Printer Settings**.
3. To change the language, select a language from the drop-down menu, and then click **Click here to submit language**.
4. Click **Printer Settings**.
5. Type the IP addresses of the source and target printers in their appropriate fields.

Note: If you want to add or remove a target printer, then click **Add Target IP** or **Remove Target IP**.

6. Click **Copy Printer Settings**.

Configuring supply notifications from the Embedded Web Server

You can determine how you would like to be notified when supplies run nearly low, low, very low, or reach their end-of-life by setting the selectable alerts.

Notes:

- Selectable alerts can be set on the toner cartridge and imaging unit.
- All selectable alerts can be set for nearly low, low, and very low supply conditions. Not all selectable alerts can be set for the end-of-life supply condition. E-mail selectable alert is available for all supply conditions.
- The percentage of estimated remaining supply that prompts the alert can be set on some supplies for some supply conditions.

1. Open a Web browser, and then type the printer IP address in the address field.

Notes:

- View the printer IP address in the TCP/IP section in the Network/Ports menu. The IP address appears as four sets of numbers separated by periods, such as 123.123.123.123.
- If you are using a proxy server, then temporarily disable it to load the Web page correctly.

2. Click **Settings >Print Settings >Supply Notifications**.

3. From the drop-down menu for each supply, select one of the following notification options:

Notification	Description
Off	The normal printer behavior for all supplies occurs.
SNMP Only	The printer generates a simple network management protocol (SNMP) alert when the supply condition is reached. The status of the supply will appear on the menus page and status page.
E-mail Only	The printer generates an e-mail when the supply condition is reached. The status of the supply will appear on the menus page and status page.
Warning	The printer displays the warning message and generates an e-mail about the status of the supply. The printer does not stop when the supply condition is reached.
Continuable Stop ¹	The printer stops processing jobs when the supply condition is reached, and the user needs to press a button to continue printing.
Non Continuable Stop ^{1,2}	The printer stops when the supply condition is reached. The supply must be replaced to continue printing.
¹ The printer generates an e-mail about the status of the supply when supply notification is enabled. ² The printer stops when some supplies become empty to prevent damage.	

4. Click **Submit**.

Printer management

Accessing the remote control panel

The remote control panel on your computer screen lets you interact with the printer control panel, even when you are not physically near the network printer. From your screen, you can view the printer status and do print-related tasks.

1. Open a Web browser, and then type the printer IP address in the address field.

Notes:

- Print a network setup page or menu settings page, and then locate the IP address in the TCP/IP section. The IP address appears as four sets of numbers separated by periods, such as 123.123.123.123.
- If you are using a proxy server, then temporarily disable it to load the Web page correctly.

2. Press **Enter** to open the Web page of your printer.
3. Click **Remote Operator Panel >Run Remote Panel**.

Note: The remote control panel requires a Java plug-in to launch.

Viewing reports

You can view some reports from the Embedded Web Server. These reports are useful for assessing the status of the printer, network, and supplies.

1. Open a Web browser, and then type the printer IP address in the address field.

Notes:

- View the printer IP address in the TCP/IP section in the Network/Ports menu. The IP address appears as four sets of numbers separated by periods, such as 123.123.123.123.
- If you are using a proxy server, then temporarily disable it to load the Web page correctly.

2. Click **Reports**, and then click the type of report you want to view.

Restoring factory default settings

If you want to keep a list of the current menu settings for reference, then print a menu settings page before restoring the factory default settings. For more information, see [Printing a menu settings page](#).

If you want a more comprehensive method of restoring the printer factory default settings, then perform the Wipe All Settings option. For more information, see [Erasing non-volatile memory](#).

Warning—Potential Damage: Restoring factory defaults returns most printer settings to the original factory default settings. Exceptions include the display language, custom sizes and messages, and Network/Port menu settings. All downloads stored in the RAM are deleted.

From the printer control panel, navigate to:



Creating a printer control panel PIN

The Panel PIN Protect menu lets you restrict access to the menus from the printer control panel. To restrict access to the menus, create a Personal Identification Number (PIN), and then assign the PIN to each menu.

1. Open a Web browser, and then type the printer IP address in the address field.

Notes:

- View the printer IP address in the TCP/IP section in the Network/Ports menu. The IP address appears as four sets of numbers separated by periods, such as 123.123.123.123.
- If you are using a proxy server, then temporarily disable it to load the Web page correctly.

2. Click **Settings >Security >Panel PIN Protect**.

3. From the Create User PIN or Create Admin PIN sections, enter your PIN.

Note: You can enter up to 16 digits for your PIN.

4. Click **Modify**.

5. From any menu in the Administrative Menus, Management, or Function Access sections, select **User PIN Protected** or **Admin PIN Protected** or **Admin PIN and User PIN Protected**.

Note: Using an Admin PIN, you can still access a menu assigned with a User PIN.

6. Click **Submit**.

If you try to access a PIN-protected menu from the printer control panel, the printer will require you to enter the PIN.

Note: After you enter the last digit of the PIN, make sure to press  on the printer control panel for more than three seconds.

Saving energy

Using Eco-Mode

Use Eco-Mode to quickly select one or more ways to reduce your printer's environmental impact.

1. From the printer control panel, navigate to:

 >**Settings** >  >**General Settings** >  >**Eco-Mode** >  > select the setting you want

Use	To
Off	Use the factory default settings for all settings associated with Eco-Mode. This setting supports the performance specifications for your printer.
Energy	Reduce energy use, especially when the printer is idle. <ul style="list-style-type: none"> • Printer engine motors do not start until a document is ready to print. You may notice a short delay before the first page is printed. • The printer enters Sleep mode after one minute of inactivity.
Energy/Paper	Use all the settings associated with Energy and Paper modes.

Use	To
Paper	<ul style="list-style-type: none"> • Enable the automatic two-sided (duplex) printing feature. • Turn off print log features.

2. Press .

Using Hibernate mode



Hibernate is an ultra-low-power saving mode.

Notes:

- Three days is the default amount of time before the printer enters Hibernate mode.
- Make sure to wake the printer from Hibernate mode before sending a print job. A hard reset or a long press of the Sleep button wakes the printer from Hibernate mode.
- If the printer is in Hibernate mode, then the Embedded Web Server is disabled.

1. From the control panel, navigate to:



2. Press **Press Sleep Button** or **Press and Hold Sleep Button**, and then press .
3. Press **Hibernate** > .

Setting Hibernate Timeout

Hibernate Timeout lets you set the amount of time the printer waits after a print job is processed before it goes into a reduced power state.

Using the Embedded Web Server

1. Open a Web browser, and then type the printer IP address in the address field.

Notes:

- Print a network setup page or menu settings page, and then locate the IP address in the TCP/IP section. The IP address appears as four sets of numbers separated by periods, such as 123.123.123.123.
 - If you are using a proxy server, then temporarily disable it to load the Web page correctly.
2. Click **Settings >General Settings >Timeouts**.
 3. From the Hibernate Timeout menu, select the number of hours, days, weeks, or months you want for the printer to wait before it goes into a reduced power state.

4. Click **Submit**.

Using the printer settings on the computer

Depending on your operating system, access the Hibernate Timeout menu using the Local Printer Settings Utility or Print Settings.

Using Schedule Power Modes

Schedule Power Modes lets the user schedule when the printer goes into a reduced power state or into the Ready state.

Using the Embedded Web Server

1. Open a Web browser, and then type the printer IP address in the address field.

Notes:

- Print a network setup page or menu settings page, and then locate the IP address in the TCP/IP section. The IP address appears as four sets of numbers separated by periods, such as 123.123.123.123.
 - If you are using a proxy server, then temporarily disable it to load the Web page correctly.
2. Click **Settings >General Settings >Schedule Power Modes**.
 3. From the Action menu, select the power mode.
 4. From the Time menu, select the time.
 5. From the Day(s) menu, select the day or days.
 6. Click **Add**.

Using the printer settings on the computer (Windows only)

- Access the Schedule Power Modes menu using the Local Printer Settings Utility.

Adjusting Sleep mode

To save energy, decrease the number of minutes before the printer enters Sleep mode.

Note: Sleep mode can be scheduled. For more information, see [Using Schedule Power Modes](#).

1. From the control panel, navigate to:



2. Select the number of minutes before the printer enters Sleep mode.
3. Apply the changes.

10—Securing the printer

Using the security lock feature

The printer is equipped with a security lock feature. Attach a security lock compatible with most laptop computers in the location shown to secure the printer in place.



Statement of Volatility

Your printer contains various types of memory that can store device and network settings, and user data.

Type of memory	Description
Volatile memory	Your printer uses standard <i>random access memory</i> (RAM) to temporarily buffer user data during simple print jobs.
Non-volatile memory	Your printer may use two forms of non-volatile memory: EEPROM and NAND (flash memory). Both types are used to store operating system, device settings, and network information.

Erase the content of any installed printer memory in the following circumstances:



- The printer is being decommissioned.
- The printer is being moved to a different department or location.

- The printer is being serviced by someone from outside your organization.
- The printer is being removed from your premises for service.
- The printer is being sold to another organization.

Erasing volatile memory

The volatile memory (RAM) installed in your printer requires a power source to retain information. To erase the buffered data, simply turn off the printer.

Erasing non-volatile memory

1. Turn off the printer.
2. From the printer control panel, hold down  and the right arrow button while turning the printer on. Release the buttons only when the Configuration menu appears.
3. Press the arrow buttons until **Wipe All Settings** appears, and then press .

The printer will restart several times during this process.

Note: Wipe All Settings securely removes device settings, solutions, jobs, and passwords from the printer memory.

4. Press the arrow buttons until **Exit Config Menu** appears, and then press .

The printer will perform a power-on reset, and then return to normal operating mode.

11—Understanding the printer menus

Menu list

Paper Menu	Reports	Network/Ports
Default Source	Menu Settings Page	Active NIC
Paper Size/Type	Device Statistics	Standard Network ²
Configure MP	Network Setup Page ¹	Standard USB
Substitute Size	Profiles List	Standard Parallel
Paper Texture	Print Fonts	SMTP Setup
Paper Weight	Print Directory	
Paper Loading	Asset Report	
Custom Types	Event Log Summary	
Universal Setup		

Security	Settings
Set Date and Time	General Settings
	Print Settings

¹ Depending on the printer setup, this menu item appears as Network Setup Page or Network [x] Setup Page.

² Depending on the printer setup, this menu item appears as Standard Network or Network [x].

Paper menu

Default Source menu

Use	To
<p>Default Source</p> <ul style="list-style-type: none"> Tray [x] MP Feeder Manual Paper Manual Envelope 	<p>Set a default paper source for all print jobs.</p> <p>Notes:</p> <ul style="list-style-type: none"> • Tray 1 (standard tray) is the factory default setting. • From the Paper menu, set Configure MP to "Cassette" for MP Feeder to appear as a menu setting. • If two trays contain paper of the same size and type, and the trays have the same settings, then the trays are automatically linked. When one tray is empty, the print job continues using the linked tray.

Paper Size/Type menu

Use	To
<p>Tray [x] Size</p> <ul style="list-style-type: none"> A4 A5 A6 JIS-B5 Letter Legal Executive Oficio (Mexico) Folio Statement Universal 	<p>Specify the paper size loaded in each tray.</p> <p>Notes:</p> <ul style="list-style-type: none"> • Letter is the U.S. factory default setting. A4 is the international factory default setting. • If two trays contain paper of the same size and type, and the trays have the same settings, then the trays are automatically linked. When one tray is empty, the print job continues using the linked tray. • The A6 paper size is supported only in Tray 1 and the multipurpose feeder.
<p>Tray [x] Type</p> <ul style="list-style-type: none"> Plain Paper Transparency Recycled Labels Bond Letterhead Preprinted Colored Paper Light Paper Heavy Paper Rough/Cotton Custom Type [x] 	<p>Specify the type of paper loaded in each tray.</p> <p>Notes:</p> <ul style="list-style-type: none"> • Plain Paper is the factory default setting for Tray 1. Custom Type [x] is the factory default setting for all other trays. • If available, a user-defined name will appear instead of Custom Type [x]. • Use this menu to configure automatic tray linking.

User's Guide

Use	To
<p>MP Feeder Size</p> <p>A4</p> <p>A5</p> <p>A6</p> <p>JIS B5</p> <p>Letter</p> <p>Legal</p> <p>Executive</p> <p>Oficio (Mexico)</p> <p>Folio</p> <p>Statement</p> <p>Universal</p> <p>7 3/4 Envelope</p> <p>9 Envelope</p> <p>10 Envelope</p> <p>DL Envelope</p> <p>C5 Envelope</p> <p>B5 Envelope</p> <p>Other Envelope</p>	<p>Specify the paper size loaded in the multipurpose feeder.</p> <p>Notes:</p> <ul style="list-style-type: none"> • Letter is the U.S. factory default setting. A4 is the international factory default setting. • From the Paper menu, set Configure MP to “Cassette” for MP Feeder Size to appear as a menu. • The multipurpose feeder does not automatically detect paper size. Make sure to set the paper size value.
<p>MP Feeder Type</p> <p>Plain Paper</p> <p>Card Stock</p> <p>Transparency</p> <p>Recycled</p> <p>Labels</p> <p>Bond</p> <p>Envelope</p> <p>Rough Envelope</p> <p>Letterhead</p> <p>Preprinted</p> <p>Colored Paper</p> <p>Light Paper</p> <p>Heavy Paper</p> <p>Rough/Cotton</p> <p>Custom Type [x]</p>	<p>Specify the type of paper loaded in the multipurpose feeder.</p> <p>Notes:</p> <ul style="list-style-type: none"> • Custom Type [x] is the factory default setting. • From the Paper menu, set Configure MP to “Cassette” for MP Feeder Type to appear as a menu.

User's Guide

Use	To
<p>Manual Paper Size</p> <ul style="list-style-type: none"> A4 A5 A6 JIS B5 Letter Legal Executive Oficio (Mexico) Folio Statement Universal 	<p>Specify the paper size being manually loaded.</p> <p>Note: Letter is the U.S. factory default setting. A4 is the international factory default setting.</p>
<p>Manual Paper Type</p> <ul style="list-style-type: none"> Plain Paper Card Stock Transparency Recycled Labels Bond Letterhead Preprinted Colored Paper Light Paper Heavy Paper Rough/Cotton Custom Type [x] 	<p>Specify the paper type being manually loaded.</p> <p>Notes:</p> <ul style="list-style-type: none"> • Plain Paper is the factory default setting. • From the Paper menu, set Configure MP to “Manual” for Manual Paper Type to appear as a menu.
<p>Manual Envelope Size</p> <ul style="list-style-type: none"> 7 3/4 Envelope 9 Envelope 10 Envelope DL Envelope C5 Envelope B5 Envelope Other Envelope 	<p>Specify the envelope size being manually loaded.</p> <p>Note: 10 Envelope is the U.S. factory default setting. DL Envelope is the international factory default setting.</p>

Use	To
Manual Envelope Type Envelope Rough Envelope Custom Type [x]	Specify the envelope type being manually loaded. Note: Envelope is the factory default setting.
Note: Only installed trays and feeders are listed in this menu.	

Configure MP menu

Use	To
Configure MP Cassette Manual First	Determine when the printer selects paper from the multipurpose feeder. Notes: <ul style="list-style-type: none"> • Cassette is the factory default setting. Cassette configures the multipurpose feeder as the default paper source. • Manual sets the multipurpose feeder only for manual-feed print jobs. • First sets the multipurpose feeder as the primary paper source regardless of settings.

Substitute Size menu

Use	To
Substitute Size Off Statement/A5 Letter/A4 All Listed	Substitute a specified paper size if the requested paper size is not available. Notes: <ul style="list-style-type: none"> • All Listed is the factory default setting. All available substitutions are allowed. • Off indicates that no size substitutions are allowed. • Setting a size substitution lets the print job continue without Change Paper appearing.

Paper Texture menu

Use	To
<p>Plain Texture</p> <p>Smooth Normal Rough</p>	<p>Specify the relative texture of the plain paper loaded.</p> <p>Note: Normal is the factory default setting.</p>
<p>Card Stock Texture</p> <p>Smooth Normal Rough</p>	<p>Specify the relative texture of the card stock loaded.</p> <p>Notes:</p> <ul style="list-style-type: none"> • Normal is the factory default setting. • The options appear only if card stock is supported.
<p>Transparency Texture</p> <p>Smooth Normal Rough</p>	<p>Specify the relative texture of the transparencies loaded.</p> <p>Note: Normal is the factory default setting.</p>
<p>Recycled Texture</p> <p>Smooth Normal Rough</p>	<p>Specify the relative texture of the recycled paper loaded.</p> <p>Note: Normal is the factory default setting.</p>
<p>Labels Texture</p> <p>Smooth Normal Rough</p>	<p>Specify the relative texture of the labels loaded.</p> <p>Note: Normal is the factory default setting.</p>
<p>Bond Texture</p> <p>Smooth Normal Rough</p>	<p>Specify the relative texture of the bond paper loaded.</p> <p>Note: Rough is the factory default setting.</p>
<p>Envelope Texture</p> <p>Smooth Normal Rough</p>	<p>Specify the relative texture of the envelopes loaded.</p> <p>Note: Normal is the factory default setting.</p>
<p>Rough Envelope Texture</p> <p>Rough</p>	<p>Specify the relative texture of the rough envelopes loaded.</p>

User's Guide

Use	To
<p>Letterhead Texture</p> <p>Smooth Normal Rough</p>	<p>Specify the relative texture of the letterhead loaded.</p> <p>Note: Normal is the factory default setting.</p>
<p>Preprinted Texture</p> <p>Smooth Normal Rough</p>	<p>Specify the relative texture of the preprinted paper loaded.</p> <p>Note: Normal is the factory default setting.</p>
<p>Colored Texture</p> <p>Smooth Normal Rough</p>	<p>Specify the relative texture of the colored paper loaded.</p> <p>Note: Normal is the factory default setting.</p>
<p>Light Texture</p> <p>Smooth Normal Rough</p>	<p>Specify the relative texture of the paper loaded.</p> <p>Note: Normal is the factory default setting.</p>
<p>Heavy Texture</p> <p>Smooth Normal Rough</p>	<p>Specify the relative texture of the paper loaded.</p> <p>Note: Normal is the factory default setting.</p>
<p>Rough/Cotton Texture</p> <p>Rough</p>	<p>Specify the relative texture of the cotton paper loaded.</p>
<p>Custom [x] Texture</p> <p>Smooth Normal Rough</p>	<p>Specify the relative texture of the custom paper loaded.</p> <p>Notes:</p> <ul style="list-style-type: none"> • Normal is the factory default setting. • The options appear only if the custom type is supported.

Paper Weight menu

Use	To
<p>Plain Weight</p> <p>Light Normal Heavy</p>	<p>Specify the relative weight of the plain paper loaded.</p> <p>Note: Normal is the factory default setting.</p>
<p>Card Stock Weight</p> <p>Light Normal Heavy</p>	<p>Specify the relative weight of the card stock loaded.</p> <p>Note: Normal is the factory default setting.</p>
<p>Transparency Weight</p> <p>Light Normal Heavy</p>	<p>Specify the relative weight of the transparencies loaded.</p> <p>Note: Normal is the factory default setting.</p>
<p>Recycled Weight</p> <p>Light Normal Heavy</p>	<p>Specify the relative weight of the recycled paper loaded.</p> <p>Note: Normal is the factory default setting.</p>
<p>Labels Weight</p> <p>Light Normal Heavy</p>	<p>Specify the relative weight of the labels loaded.</p> <p>Note: Normal is the factory default setting.</p>
<p>Bond Weight</p> <p>Light Normal Heavy</p>	<p>Specify the relative weight of the bond paper loaded.</p> <p>Note: Normal is the factory default setting.</p>
<p>Envelope Weight</p> <p>Light Normal Heavy</p>	<p>Specify the relative weight of the envelope loaded.</p> <p>Note: Normal is the factory default setting.</p>

User's Guide

Use	To
<p>Rough Envelope Weight</p> <p>Light Normal Heavy</p>	<p>Specify the relative weight of the rough envelope loaded.</p> <p>Note: Normal is the factory default setting.</p>
<p>Letterhead Weight</p> <p>Light Normal Heavy</p>	<p>Specify the relative weight of the letterhead loaded.</p> <p>Note: Normal is the factory default setting.</p>
<p>Preprinted Weight</p> <p>Light Normal Heavy</p>	<p>Specify the relative weight of the preprinted paper loaded.</p> <p>Note: Normal is the factory default setting.</p>
<p>Colored Weight</p> <p>Light Normal Heavy</p>	<p>Specify the relative weight of the colored paper loaded.</p> <p>Note: Normal is the factory default setting.</p>
<p>Light Weight</p> <p>Light</p>	<p>Specify that the weight of the paper loaded is light.</p>
<p>Heavy Weight</p> <p>Heavy</p>	<p>Specify that the weight of the paper loaded is heavy.</p>
<p>Rough/Cotton Weight</p> <p>Light Normal Heavy</p>	<p>Specify the relative weight of the cotton or rough paper loaded.</p> <p>Note: Heavy is the factory default setting.</p>
<p>Custom [x] Weight</p> <p>Light Normal Heavy</p>	<p>Specify the relative weight of the custom paper loaded.</p> <p>Notes:</p> <ul style="list-style-type: none"> • Normal is the factory default setting. • The options appear only when the custom type is supported.

Paper Loading menu

Use	To
<p>Recycled Loading</p> <p>Duplex</p> <p>Off</p>	<p>Determine and set two-sided printing for all print jobs that specify Recycled as the paper type.</p>
<p>Bond Loading</p> <p>Duplex</p> <p>Off</p>	<p>Determine and set two-sided printing for all print jobs that specify Bond as the paper type.</p>
<p>Letterhead Loading</p> <p>Duplex</p> <p>Off</p>	<p>Determine and set two-sided printing for all print jobs that specify Letterhead as the paper type.</p>
<p>Preprinted Loading</p> <p>Duplex</p> <p>Off</p>	<p>Determine and set two-sided printing for all print jobs that specify Preprinted as the paper type.</p>
<p>Colored Loading</p> <p>Duplex</p> <p>Off</p>	<p>Determine and set two-sided printing for all print jobs that specify Colored as the paper type.</p>
<p>Light Loading</p> <p>Duplex</p> <p>Off</p>	<p>Determine and set two-sided printing for all print jobs that specify Light as the paper type.</p>
<p>Heavy Loading</p> <p>Duplex</p> <p>Off</p>	<p>Determine and set two-sided printing for all print jobs that specify Heavy as the paper type.</p>
<p>Custom [x] Loading</p> <p>Duplex</p> <p>Off</p>	<p>Determine and set two-sided printing for all print jobs that specify Custom [x] as the paper type.</p> <p>Note: Custom [x] Loading is available only if the custom type is supported.</p>
<p>Notes:</p> <ul style="list-style-type: none"> • Duplex sets two-sided printing as the default for all print jobs unless one-sided printing is set from Printing Preferences or Print dialog. • If Duplex is selected, then all print jobs are sent through the duplex unit, including one-sided jobs. • Off is the factory default setting for all the menus. 	

Custom Types menu

Use	To
<p>Custom Type [x]</p> <ul style="list-style-type: none"> Paper Card Stock Transparency Rough/Cotton Labels Envelope 	<p>Associate a paper or specialty media type with a Custom Type [x] name.</p> <p>Notes:</p> <ul style="list-style-type: none"> • Paper is the factory default setting for Custom Type [x]. • The specialty media type must be supported in the selected tray or feeder in order to print from that source.
<p>Recycled</p> <ul style="list-style-type: none"> Paper Card Stock Transparency Rough/Cotton Labels Envelope 	<p>Specify a paper type when the Recycled setting is selected in other menus.</p> <p>Notes:</p> <ul style="list-style-type: none"> • Paper is the factory default setting. • The Recycled paper type must be supported in the selected tray or feeder in order to print from that source.

Universal Setup menu

Use	To
<p>Units of Measure</p> <p>Inches</p> <p>Millimeters</p>	<p>Identify the units of measure.</p> <p>Notes:</p> <ul style="list-style-type: none"> Inches is the US default setting. Millimeters is the Non-US default setting.
<p>Portrait Width</p> <p>3–8.5 inches</p> <p>76–216 mm</p>	<p>Set the portrait width.</p> <p>Notes:</p> <ul style="list-style-type: none"> If the width exceeds the maximum, then the printer uses the maximum width allowed. 8.5 inches is the US default setting. You can increase the width in 0.01-inch increments. 216 mm is the Non-US default setting. You can increase the width in 1-mm increments.
<p>Portrait Height</p> <p>3–14.17 inches</p> <p>76–360 mm</p>	<p>Set the portrait height.</p> <p>Notes:</p> <ul style="list-style-type: none"> If the height exceeds the maximum, then the printer uses the maximum height allowed. 14 inches is the US default setting. You can increase the height in 0.01-inch increments. 360 mm is the Non-US default setting. You can increase the height in 1-mm increments.
<p>Feed Direction</p> <p>Short Edge</p> <p>Long Edge</p>	<p>Specify the feed direction if the paper can be loaded in either direction.</p> <p>Notes:</p> <ul style="list-style-type: none"> Short Edge is the factory default setting. Long Edge appears only when the longest edge is shorter than the maximum width supported in the tray.

Reports menu

Reports menu

Use	To
Menu Settings Page	Print a report containing information about the paper loaded in trays, installed memory, total page count, alarms, timeouts, control panel language, TCP/IP address, status of supplies, status of the network connection, and other information.
Device Statistics	Print a report containing printer statistics, such as supply information and details about printed pages.
Network Setup Page	Print a report containing information about the network printer settings, such as the TCP/IP address information. Note: This menu item appears only in network printers or in printers connected to print servers.
Profiles List	Print a list of profiles stored in the printer. Note: This menu item appears only when LDSS is enabled.
Print Fonts PCL Fonts PostScript Fonts	Print a report of all the fonts available for the printer language currently set in the printer. Note: A separate list is available for PCL and PostScript emulations.
Print Directory	Print a list of all the resources stored in an optional flash memory card. Notes: <ul style="list-style-type: none"> • Job Buffer Size must be set to 100%. • Make sure the optional flash memory card is installed correctly and working properly. • This menu item appears only when an optional flash memory card is installed.
Asset Report	Print a report containing printer asset information, such as serial number and model name.
Event Log Summary	Print a report containing a summary of all logged events.

Network/Ports menu

The menus in this section only appear in network printers or printers connected to print servers.

Active NIC menu

Use	To
Active NIC Auto [list of available network cards]	Notes: <ul style="list-style-type: none"> • Auto is the factory default setting. • This menu item appears only when an optional network card is installed.

Standard Network or Network [x] menu

Note: Only active ports appear in this menu. All inactive ports are omitted.

Use	To
Energy Efficient Ethernet Enable Disable	Set the printer Ethernet connection to a energy-saving mode. Note: Enable is the factory default setting.
PCL SmartSwitch On Off	Set the printer to automatically switch to PCL emulation when a print job requires it, regardless of the default printer language. Notes: <ul style="list-style-type: none"> • On is the factory default setting. • If PCL SmartSwitch is disabled, then the printer does not examine incoming data and it uses the default printer language specified in the Setup menu.
PS SmartSwitch On Off	Set the printer to automatically switch to PS emulation when a print job requires it, regardless of the default printer language. Notes: <ul style="list-style-type: none"> • On is the factory default setting. • If PS SmartSwitch is disabled, then the printer does not examine incoming data and it uses the default printer language specified in the Setup menu.

User's Guide

Use	To
<p>NPA Mode</p> <p>Off</p> <p>Auto</p>	<p>Set the printer to perform the special processing required for bidirectional communication following the conventions defined by the NPA protocol.</p> <p>Notes:</p> <ul style="list-style-type: none"> • Auto is the factory default setting. • Changing this setting from the control panel and then exiting the menus causes the printer to restart. The menu selection is then updated.
<p>Network Buffer</p> <p>Disabled</p> <p>Auto</p> <p>3KB to [maximum size allowed]</p>	<p>Set the size of the network input buffer.</p> <p>Notes:</p> <ul style="list-style-type: none"> • Auto is the factory default setting. • The value can be changed in 1-KB increments. • The maximum size allowed depends on the amount of memory in the printer, the size of the other link buffers, and whether Resource Save is set to On or Off. • To increase the maximum size range for the Network Buffer, disable or reduce the size of the parallel, serial, and USB buffers. • Changing this setting from the control panel and then exiting the menus causes the printer to restart. The menu selection is then updated.
<p>Mac Binary PS</p> <p>On</p> <p>Off</p> <p>Auto</p>	<p>Set the printer to process Macintosh binary PostScript print jobs.</p> <p>Notes:</p> <ul style="list-style-type: none"> • Auto is the factory default setting. • Off filters print jobs using the standard protocol. • On processes raw binary PostScript print jobs.
<p>Standard Network Setup OR Network [x] Setup</p> <p>Reports</p> <p>Network Card</p> <p>TCP/IP</p> <p>IPv6</p> <p>Wireless</p> <p>AppleTalk</p>	<p>Display and set the printer network settings.</p> <p>Note: The Wireless menu appears only when the printer is connected to a wireless network.</p>

Reports menu

To access the menu, navigate to either of the following:

- **Network/Ports >Standard Network >Standard Network Setup >Reports**
- **Network/Ports >Network [x] >Network [x] Setup >Reports**

Use	To
Print Setup Page	Print a report containing information about the network printer settings, such as the TCP/IP address.

Wireless menu

Note: This menu is available only in printers connected to a wireless network or printer models that have a wireless network adapter.

To access the menu, navigate to any of the following:

- **Network/Ports >Network [x] >Network [x] Setup >Wireless**

Use	To
Network Mode Infrastructure Ad hoc	Specify the network mode. Notes: <ul style="list-style-type: none"> • Ad hoc is the factory default setting. This configures wireless connection directly between the printer and a computer. • Infrastructure lets the printer access a network using an access point.
Compatibility 802.11b/g 802.11b/g/n	Specify the wireless standard for the wireless network. Note: The 802.11b/g/n is the factory default setting.
Choose Network	Select an available network for the printer to use.
View Signal Quality	View the quality of the wireless connection.
View Security Mode	View the encryption method for the wireless network.

Network Card menu

Use	To
<p>View Card Status</p> <p>Connected Disconnected</p>	<p>View the connection status of the network card.</p>
<p>View Card Speed</p>	<p>View the speed of an active network card.</p>
<p>Network Address</p> <p>UAA LAA</p>	<p>View the network addresses.</p>
<p>Job Timeout</p> <p>0–255 seconds</p>	<p>Set the amount of time it takes for a network print job to be canceled.</p> <p>Notes:</p> <ul style="list-style-type: none"> • 90 seconds is the factory default setting. • A setting value of 0 disables the timeout. • If a value of 1–9 is selected, then the setting is saved as 10.
<p>Banner Page</p> <p>Off On</p>	<p>Enable banner pages.</p> <p>Note: Off is the factory default setting</p>

TCP/IP menu

Note: This menu is available only in network printers or printers connected to print servers.

Use	To
Set Hostname	Set the host name. Notes: <ul style="list-style-type: none"> • This setting can be changed only from the Embedded Web Server. • The host name can be up to 15 characters and can be a US-ASCII or alphanumeric character, or hyphen.
IP Address	View or change the current TCP/IP address. Note: Manually setting the IP address sets the Enable DHCP and Enable Auto IP settings to Off. It also sets Enable BOOTP and Enable RARP to Off on systems that support BOOTP and RARP.
Netmask	View or change the current TCP/IP netmask.
Gateway	View or change the current TCP/IP gateway.
Enable DHCP On Off	Specify the DHCP address and parameter assignment. Note: On is the factory default setting.
Enable RARP Off On	Specify the RARP address assignment setting. Note: Off is the factory default setting.
Enable BOOTP Off On	Specify the BOOTP address assignment setting. Note: Off is the factory default setting.
Enable AutoIP Yes No	Specify the Zero Configuration Networking setting. Note: Yes is the factory default setting.
Enable FTP/TFTP Yes No	Enable the built-in FTP server, which lets you send files to the printer using File Transfer Protocol. Note: Yes is the factory default setting.

User's Guide

Use	To
<p>Enable HTTP Server</p> <p>Yes</p> <p>No</p>	<p>Enable the built-in Web server (Embedded Web Server). When enabled, the printer can be monitored and managed remotely using a Web browser.</p> <p>Note: Yes is the factory default setting.</p>
<p>WINS Server Address</p>	<p>View or change the current WINS server address.</p>
<p>Enable DDNS</p> <p>Yes</p> <p>No</p>	<p>View or change the current DDNS setting.</p> <p>Note: Yes is the factory default setting.</p>
<p>Enable mDNS</p> <p>Yes</p> <p>No</p>	<p>View or change the current mDNS setting.</p> <p>Note: Yes is the factory default setting.</p>
<p>DNS Server Address</p>	<p>View or change the current DNS server address.</p>
<p>Backup DNS Server Address</p>	<p>View or change the backup DNS server addresses.</p>
<p>Backup DNS Server Address 2</p>	
<p>Backup DNS Server Address 3</p>	
<p>Enable HTTPS</p> <p>Yes</p> <p>No</p>	<p>View or change the current HTTPS setting.</p> <p>Note: Yes is the factory default setting.</p>

IPv6 menu

To access the menu, navigate to any of the following:

- **Network/Ports >Standard Network >Standard Network Setup >IPv6**
- **Network/Ports >Network [x] >Network [x] Setup >IPv6**

Note: This menu is available only in network printers or printers connected to print servers.

Use	To
Enable IPv6 On Off	Enable Internet Protocol Version Six (IPv6) in the printer. IPv6 uses bigger numbers to create IP addresses. Note: On is the factory default setting.
Auto Configuration On Off	Specify whether or not the network adapter accepts the automatic IPv6 address configuration entries provided by a router. Note: On is the factory default setting.
Set Hostname	Set the host name. Note: The host name is limited to 15 characters, and accepts US-ASCII, alphanumeric characters and hyphen only.
View Address	View the current IPv6 addresses.
View Router Address	View the current router address.
Enable DHCPv6 On Off	Enable DHCPv6 in the printer. Note: On is the factory default setting.

Standard USB menu

Use	To
<p>PCL SmartSwitch</p> <p>On</p> <p>Off</p>	<p>Set the printer to automatically switch to PCL emulation when a print job received through a USB port requires it, regardless of the default printer language.</p> <p>Notes:</p> <ul style="list-style-type: none"> • On is the factory default setting. • When set to Off, the printer does not examine incoming data. The printer uses PostScript emulation if the PS SmartSwitch is set to On. It uses the default printer language specified in the Setup menu if the PS SmartSwitch is set to Off.
<p>PS SmartSwitch</p> <p>On</p> <p>Off</p>	<p>Set the printer to automatically switch to PS emulation when a print job received through a USB port requires it, regardless of the default printer language.</p> <p>Notes:</p> <ul style="list-style-type: none"> • On is the factory default setting. • When set to Off, the printer does not examine incoming data. The printer uses PCL emulation if the PCL SmartSwitch is set to On. It uses the default printer language specified in the Setup menu if the PCL SmartSwitch is set to Off.
<p>NPA Mode</p> <p>On</p> <p>Off</p> <p>Auto</p>	<p>Set the printer to perform the special processing required for bidirectional communication following the conventions defined by the NPA protocol.</p> <p>Note: Auto is the factory default setting. Auto sets the printer to examine data, determine the format, and then process it appropriately.</p>
<p>USB Buffer</p> <p>Disabled</p> <p>Auto</p> <p>3K to [maximum size allowed]</p>	<p>Set the size of the USB input buffer.</p> <p>Notes:</p> <ul style="list-style-type: none"> • Auto is the factory default setting. • Disabled turns off job buffering. • The USB buffer size value can be changed in 1-KB increments. • The maximum size allowed depends on the amount of memory in the printer, the size of the other link buffers, and whether Resource Save is set to On or Off. • To increase the maximum size range for USB Buffer, disable or reduce the size of the parallel, serial, and network buffers. • The printer automatically restarts when the setting is changed from the printer control panel. The menu selection is then updated.

User's Guide

Use	To
<p>Mac Binary PS</p> <p>On Off Auto</p>	<p>Set the printer to process Macintosh binary PostScript print jobs.</p> <p>Notes:</p> <ul style="list-style-type: none"> • Auto is the factory default setting. • On processes raw binary PostScript print jobs. • Off filters print jobs using the standard protocol.
<p>ENA Address</p> <p>yyy.yyy.yyy.yyy</p>	<p>Set the network address information for an external print server.</p> <p>Note: This menu is available only when the printer is attached to an external print server through the USB port.</p>
<p>ENA Netmask</p> <p>yyy.yyy.yyy.yyy</p>	<p>Set the netmask information for an external print server.</p> <p>Note: This menu is available only when the printer is attached to an external print server through the USB port.</p>
<p>ENA Gateway</p> <p>yyy.yyy.yyy.yyy</p>	<p>Set the gateway information for an external print server.</p> <p>Note: This menu is available only when the printer is attached to an external print server through the USB port.</p>

Standard Parallel menu

Use	To
<p>PCL SmartSwitch</p> <p>On</p> <p>Off</p>	<p>Set the printer to automatically switch to PCL emulation when a print job received through a serial port requires it, regardless of the default printer language.</p> <p>Notes:</p> <ul style="list-style-type: none"> • On is the factory default setting. • When set to Off, the printer does not examine incoming data. The printer uses PostScript emulation if PS SmartSwitch is set to On. It uses the default printer language specified in the Setup menu if PS SmartSwitch is set to Off.
<p>PS SmartSwitch</p> <p>On</p> <p>Off</p>	<p>Set the printer to automatically switch to PS emulation when a print job received through a serial port requires it, regardless of the default printer language.</p> <p>Notes:</p> <ul style="list-style-type: none"> • On is the factory default setting. • When set to Off, the printer does not examine incoming data. The printer uses PCL emulation if PCL SmartSwitch is set to On. It uses the default printer language specified in the Setup menu if PCL SmartSwitch is set to Off.
<p>NPA Mode</p> <p>On</p> <p>Off</p> <p>Auto</p>	<p>Set the printer to perform the special processing required for bidirectional communication following the conventions defined by the NPA protocol.</p> <p>Notes:</p> <ul style="list-style-type: none"> • Auto is the factory default setting. • Changing this setting from the control panel and then exiting the menus causes the printer to restart. The menu selection is then updated.

User's Guide

Use	To
<p>Parallel Buffer</p> <p>Disabled Auto 3K to [maximum size allowed]</p>	<p>Set the size of the parallel input buffer.</p> <p>Notes:</p> <ul style="list-style-type: none"> • Auto is the factory default setting. • Disabled turns off job buffering. Any print jobs already buffered on the printer hard disk are printed before normal processing resumes. • The parallel buffer size setting can be changed in 1-KB increments. • The maximum size allowed depends on the amount of memory in the printer, the size of the other link buffers, and whether Resource Save is set to On or Off. • To increase the maximum size range for the Parallel Buffer, disable or reduce the size of the USB, serial, and network buffers. • Changing this setting from the control panel and then exiting the menus causes the printer to restart. The menu selection is then updated.
<p>Advanced Status</p> <p>On Off</p>	<p>Enable bidirectional communication through the parallel port.</p> <p>Notes:</p> <ul style="list-style-type: none"> • On is the factory default setting. • Off disables parallel port negotiation.
<p>Protocol</p> <p>Standard Fastbytes</p>	<p>Specify the parallel port protocol.</p> <p>Notes:</p> <ul style="list-style-type: none"> • Fastbytes is the factory default setting. It provides compatibility with most existing parallel ports and is the recommended setting. • Standard tries to resolve parallel port communication problems.
<p>Honor Init</p> <p>On Off</p>	<p>Determine if the printer honors printer hardware initialization requests from the computer.</p> <p>Notes:</p> <ul style="list-style-type: none"> • Off is the factory default setting. • The computer requests initialization by activating the Init signal from the parallel port. Many personal computers activate the Init signal each time the computer is turned on.
<p>Parallel Mode 2</p> <p>On Off</p>	<p>Determine if the parallel port data is sampled on the leading or trailing edge of a strobe.</p> <p>Note: On is the factory default setting.</p>

User's Guide

Use	To
<p>Mac Binary PS</p> <p>On Off Auto</p>	<p>Set the printer to process Macintosh binary PostScript print jobs.</p> <p>Notes:</p> <ul style="list-style-type: none"> • Auto is the factory default setting. • Off filters print jobs using the standard protocol. • On processes raw binary PostScript print jobs.
<p>ENA Address</p> <p>yyy.yyy.yyy.yyy</p>	<p>Set the network address information for an external print server.</p> <p>Note: This menu item is available only if the printer is attached to an external print server through the USB port.</p>
<p>ENA Netmask</p> <p>yyy.yyy.yyy.yyy</p>	<p>Set the netmask information for an external print server.</p> <p>Note: This menu item is available only if the printer is attached to an external print server through the USB port.</p>
<p>ENA Gateway</p> <p>yyy.yyy.yyy.yyy</p>	<p>Set the gateway information for an external print server.</p> <p>Note: This menu item is available only if the printer is attached to an external print server through the USB port.</p>

AppleTalk menu

To access the menu, navigate to either of the following:

- **Network/Ports >Standard Network >Standard Network Setup >AppleTalk**
- **Network/Ports >Network [x] >Network [x] Setup >AppleTalk**

Use	To
Activate Yes No	Enable or disable AppleTalk support. Note: No is the factory default setting.
View Name	Show the assigned AppleTalk name. Note: The AppleTalk name can be changed only from the Embedded Web Server.
View Address	Show the assigned AppleTalk address. Note: The AppleTalk address can be changed only from the Embedded Web Server.
Set Zone [list of zones available on the network]	Provide a list of AppleTalk zones available on the network. Note: The default zone for the network is the factory default setting.

SMTP Setup menu

Use	To
Primary SMTP Gateway	Specify SMTP server gateway and port information. Note: 25 is the default SMTP gateway port.
Primary SMTP Gateway Port	
Secondary SMTP Gateway	
Secondary SMTP Gateway Port	
SMTP Timeout 5–30	Specify the amount of time in seconds before the server stops trying to send an e-mail. Note: 30 seconds is the factory default setting.
Reply Address	Specify a reply address of up to 128 characters in the e-mail sent by the printer.
Use SSL Disabled Negotiate Required	Set the printer to use SSL for increased security when connecting to the SMTP server. Notes: <ul style="list-style-type: none">• Disabled is the factory default setting.• When the Negotiate setting is used, the SMTP server determines if SSL will be used.
SMTP Server Authentication No authentication required Login/Plain CRAM-MD5 Digest-MD5 NTLM Kerberos 5	Specify the type of user authentication required for printing privileges. Note: "No authentication required" is the factory default setting.
Device-Initiated E-mail None Use Device SMTP Credentials	Specify what credentials will be used when communicating to the SMTP server. Some SMTP servers require credentials to send an e-mail. Notes:
Device Userid	<ul style="list-style-type: none">• None is the factory default setting for Device-Initiated E-mail.
Device Password	<ul style="list-style-type: none">• Device Userid and Device Password are used to log in to the SMTP server when Use Device SMTP Credentials is selected.

Security menu

Set Date and Time menu

Use	To
<p>Current Date and Time</p>	<p>View the current date and time settings for the printer.</p> <p>Note: The date and time are set in YYYY-MM-DD HH:MM format.</p>
<p>Manually Set Date and Time</p> <p>[input date/time]</p>	<p>Enter the date and time.</p> <p>Note: Setting the date and time using this menu automatically sets Enable NTP to Off.</p>
<p>Time Zone</p> <p>[list of time zones]</p>	<p>Select the time zone.</p> <p>Note: GMT is the factory default setting.</p>
<p>Automatically observe DST</p> <p>On</p> <p>Off</p>	<p>Set the printer to use the applicable daylight saving time (DST) start and end times associated with the printer Time Zone setting.</p> <p>Note: On is the factory default setting.</p>
<p>Enable NTP</p> <p>On</p> <p>Off</p>	<p>Enable Network Time Protocol, which synchronizes the clocks of devices on a network.</p> <p>Notes:</p> <ul style="list-style-type: none"> • On is the factory default setting. • Enable NTP is automatically set to Off if you manually set the date and time.

Settings menu

General Settings menu

Use	To
<p>Display Language</p> <ul style="list-style-type: none"> English Francais Deutsch Italiano Espanol Dansk Norsk Nederlands Svenska Portuguese Suomi Russian Polski Greek Magyar Turkce Cesky Simplified Chinese Traditional Chinese Korean Japanese 	<p>Set the language of the text appearing on the display.</p>
<p>Show Supply Estimates</p> <ul style="list-style-type: none"> Show estimates Do not show estimates 	<p>View the estimates of the supplies on the control panel, Embedded Web Server, menu settings, and device statistics reports.</p>
<p>Eco-Mode</p> <ul style="list-style-type: none"> Off Energy Energy/Paper Paper 	<p>Minimize the use of energy, paper, or specialty media.</p> <p>Note: Off is the factory default setting. This resets the printer to its factory default settings.</p>

User's Guide

Use	To
<p>Quiet Mode</p> <p>Off</p> <p>On</p>	<p>Minimize the printer noise.</p> <p>Note: Off is the factory default setting.</p>
<p>Run Initial setup</p> <p>Yes</p> <p>No</p>	<p>Run the setup wizard.</p>
<p>Paper Sizes</p> <p>US</p> <p>Metric</p>	<p>Specify the unit of measurement for paper sizes.</p> <p>Notes:</p> <ul style="list-style-type: none"> • US is the US factory default setting. Metric is the international default setting. • The initial setting is determined by your country or region selection in the initial setup wizard.
<p>Timeouts</p> <p>Sleep Mode</p> <p>Disabled</p> <p>1–120</p>	<p>Set the amount of time in minutes the printer waits after a job is printed before it goes into a reduced power state.</p> <p>Notes:</p> <ul style="list-style-type: none"> • 20 is the factory default setting. • Disabled appears only when Energy Conserve is set to Off. • The maximum amount of time is increased to 240 minutes when Energy Conserve is set to Off. • Lower settings conserve more energy, but may require longer warm-up times. • Select a high setting if the printer is in constant use. Under most circumstances, this keeps the printer ready to print with minimum warm-up time.
<p>Timeouts</p> <p>Print with Display Off</p> <p>Allow printing with display off</p> <p>Display on when printing</p>	<p>Print a job with the display turned off.</p> <p>Note: Display on when printing is the factory default setting.</p>

User's Guide

Use	To
<p>Timeouts</p> <p>Hibernate Timeout</p> <ul style="list-style-type: none"> Disabled 20 minutes 1–3 hours 6 hours 1–3 days 1–2 weeks 1 month 	<p>Set the amount of time the printer waits before it enters Hibernate mode.</p> <p>Note: 3 days is the factory default setting.</p>
<p>Timeouts</p> <p>Hibernate Timeout on Connection</p> <ul style="list-style-type: none"> Hibernate Do Not Hibernate 	<p>Set the printer to Hibernate mode even if there is an active Ethernet connection.</p> <p>Note: Do Not Hibernate is the factory default setting.</p>
<p>Timeouts</p> <p>Screen Timeout</p> <p>15–300</p>	<p>Set the amount of time in seconds before returning the control panel to a Ready state.</p> <p>Note: 30 is the factory default setting.</p>
<p>Timeouts</p> <p>Print Timeout</p> <ul style="list-style-type: none"> Disabled 1–255 	<p>Set the amount of time in seconds the printer waits to receive an end-of-job message before canceling the rest of the job.</p> <p>Notes:</p> <ul style="list-style-type: none"> • 90 is the factory default setting. • When the timer expires, any partially printed page still in the printer is printed, and then the printer checks to see if any new print jobs are waiting. • Print Timeout is available only when using PCL emulation. This setting has no effect on PostScript emulation print jobs.
<p>Timeouts</p> <p>Wait Timeout</p> <ul style="list-style-type: none"> Disabled 15–65535 	<p>Set the amount of time in seconds the printer waits for additional data before canceling a print job.</p> <p>Note: 40 is the factory default setting.</p>

User's Guide

Use	To
<p>Error Recovery</p> <p>Auto Reboot</p> <p> Reboot when idle</p> <p> Reboot always</p> <p> Reboot never</p> <p>Max Auto Reboots</p> <p> 1–20</p>	<p>Set the printer to restart when an error occurs.</p> <p>Notes:</p> <ul style="list-style-type: none"> • Reboot always is the factory default setting for Auto Reboot. • 2 is the factory default setting for Max Auto Reboots.
<p>Print Recovery</p> <p>Auto Continue</p> <p> Disabled</p> <p> 5–255</p>	<p>Let the printer automatically continue printing from certain offline situations when these are not resolved within the specified time period.</p> <p>Note: Disabled is the factory default setting.</p>
<p>Print Recovery</p> <p>Jam Recovery</p> <p> On</p> <p> Off</p> <p> Auto</p>	<p>Specify whether the printer reprints jammed pages.</p> <p>Note: Auto is the factory default setting. The printer reprints jammed pages unless the memory required to hold the pages is needed for other printer tasks.</p>
<p>Print Recovery</p> <p>Jam Assist</p> <p> On</p> <p> Off</p>	<p>Set the printer to automatically check for jammed paper.</p> <p>Notes:</p> <ul style="list-style-type: none"> • On is the factory default setting. This sets the printer to automatically dump blank pages or partially printed pages to the standard bin after a jammed page has been cleared. • Off requires the user to remove all pages from all possible jam locations.
<p>Print Recovery</p> <p>Page Protect</p> <p> Off</p> <p> On</p>	<p>Successfully print a page that may not have printed otherwise.</p> <p>Notes:</p> <ul style="list-style-type: none"> • Off is the factory default setting. This prints a partial page when there is not enough memory to print the whole page. • On sets the printer to process the whole page so that the entire page prints.
<p>Press Sleep Button</p> <p>Do nothing</p> <p>Sleep</p> <p>Hibernate</p>	<p>Determine how the printer, while in idle state, reacts to a short press of the Sleep button.</p> <p>Note: Sleep is the factory default setting.</p>

User's Guide

Use	To
<p>Press and Hold Sleep Button</p> <p>Do nothing</p> <p>Sleep</p> <p>Hibernate</p>	<p>Determine how the printer, while in idle state, reacts to a long press of the Sleep button.</p> <p>Note: Do nothing is the factory default setting.</p>
<p>Factory Defaults</p> <p>Do Not Restore</p> <p>Restore Now</p>	<p>Use the printer factory default settings except the Network/Ports menu settings.</p> <p>Notes:</p> <ul style="list-style-type: none"> • Do Not Restore is the factory default setting. • Restore Now deletes all downloads stored in RAM. Downloads stored in the flash memory are not affected.
<p>Custom Home Message</p> <p>Off</p> <p>IP Address</p> <p>Hostname</p> <p>Contact Name</p> <p>Location</p> <p>Zero Configuration Name</p> <p>Custom Text 1</p>	<p>Select a custom home message that appears as an alternating display of the printer status.</p> <p>Note: Off is the factory default setting.</p>

Print Settings

Setup menu

Use	To
<p>Printer Language</p> <p>PCL Emulation</p> <p>PS Emulation</p>	<p>Set the default printer language.</p> <p>Notes:</p> <ul style="list-style-type: none"> • PCL Emulation is the factory default setting. • PostScript emulation uses a PostScript interpreter for processing print jobs. • PCL Emulation uses a PCL interpreter for processing print jobs. • Setting a printer language default does not prevent a software program from sending print jobs that use another printer language.
<p>Print Area</p> <p>Normal</p> <p>Whole Page</p>	<p>Set the logical and physical printable area.</p> <p>Notes:</p> <ul style="list-style-type: none"> • Normal is the factory default setting. When attempting to print data on the non-printable area defined by the Normal setting, the printer clips the image at the boundary. • Whole Page allows the image to be moved into the non-printable area defined by the Normal setting. This setting affects only pages printed using a PCL 5 interpreter and has no effect on pages printed using the PCL XL or PostScript interpreter.
<p>Download Target</p> <p>RAM</p> <p>Flash</p>	<p>Set the storage location for downloads.</p> <p>Notes:</p> <ul style="list-style-type: none"> • RAM is the factory default setting. Storing downloads in the RAM is temporary. • Storing downloads in a flash memory places them in permanent storage. Downloads remain in the flash memory even when the printer is turned off. • This menu item appears only when an optional flash memory is installed.

User's Guide

Use	To
<p>Resource Save</p> <p>On</p> <p>Off</p>	<p>Specify how the printer handles temporary downloads, such as fonts and macros stored in the RAM, when the printer receives a print job that requires more than the available memory.</p> <p>Notes:</p> <ul style="list-style-type: none">• Off is the factory default setting. Off sets the printer to retain downloads only until memory is needed. Downloads are deleted in order to process print jobs.• On sets the printer to retain downloads during language changes and printer resets. If the printer runs out of memory, then Memory Full [38] appears on the printer display, but downloads are not deleted.

Finishing menu

Use	To
<p>Sides (Duplex)</p> <p>1 sided</p> <p>2 sided</p>	<p>Specify whether two-sided (duplex) printing is set as the default for all print jobs.</p> <p>Notes:</p> <ul style="list-style-type: none"> • “1 sided” is the factory default setting. • You can set two-sided printing from the software program. <p>For Windows users:</p> <ol style="list-style-type: none"> 1. Click File >Print. 2. Click Properties, Preferences, Options, or Setup. <p>For Macintosh users:</p> <ol style="list-style-type: none"> 1. Choose File >Print. 2. Adjust the settings from the print dialog and pop-up menus.
<p>Duplex Binding</p> <p>Long Edge</p> <p>Short Edge</p>	<p>Define the way two-sided pages are bound and printed.</p> <p>Notes:</p> <ul style="list-style-type: none"> • Long Edge is the factory default setting. Long Edge binds pages along their long edge (left edge for portrait and top edge for landscape). • Short Edge binds pages along their short edge (top edge for portrait and left edge for landscape).
<p>Copies</p> <p>1–999</p>	<p>Specify the default number of copies for each print job.</p> <p>Note: 1 is the factory default setting.</p>
<p>Blank Pages</p> <p>Do Not Print</p> <p>Print</p>	<p>Specify whether to insert blank pages in a print job.</p> <p>Note: Do Not Print is the factory default setting.</p>
<p>Collate</p> <p>(1,1,1) (2,2,2)</p> <p>(1,2,3) (1,2,3)</p>	<p>Stack the pages of a print job in sequence when printing multiple copies.</p> <p>Note: “(1,2,3) (1,2,3)” is the factory default setting.</p>

User's Guide

Use	To
<p>Separator Sheets</p> <p>Off</p> <p>Between Copies</p> <p>Between Jobs</p> <p>Between Pages</p>	<p>Specify whether to insert blank separator sheets.</p> <p>Notes:</p> <ul style="list-style-type: none"> • Off is the factory default setting. • Between Copies inserts a blank sheet between each copy of a print job if Collate is set to (1,1,1) (2,2,2). If Collate is set to (1,2,3) (1,2,3), then a blank page is inserted between each set of printed pages, such as after all page 2's and after all page 3's. • Between Jobs inserts a blank sheet between print jobs. • Between Pages inserts a blank sheet between each page of a print job. This setting is useful when printing transparencies or when inserting blank pages in a document.
<p>Separator Source</p> <p>Tray [x]</p> <p>Multi-Purpose Feeder</p>	<p>Specify the paper source for separator sheets.</p> <p>Note: Tray 1 (standard tray) is the factory default setting.</p>
<p>Paper Saver</p> <p>Off</p> <p>2-Up</p> <p>3-Up</p> <p>4-Up</p> <p>6-Up</p> <p>9-Up</p> <p>12-Up</p> <p>16-Up</p>	<p>Print multiple-page images on one side of a paper.</p> <p>Notes:</p> <ul style="list-style-type: none"> • Off is the factory default setting. • The number selected is the number of page images that will print per side.
<p>Paper Saver Ordering</p> <p>Horizontal</p> <p>Reverse Horizontal</p> <p>Reverse Vertical</p> <p>Vertical</p>	<p>Specify the positioning of multiple-page images when using Paper Saver.</p> <p>Notes:</p> <ul style="list-style-type: none"> • Horizontal is the factory default setting. • Positioning depends on the number of page images and whether they are in portrait or landscape orientation.
<p>Paper Saver Orientation</p> <p>Auto</p> <p>Landscape</p> <p>Portrait</p>	<p>Specify the orientation of a multiple-page document.</p> <p>Note: Auto is the factory default setting. The printer chooses between portrait and landscape.</p>

User's Guide

Use	To
Paper Saver Border None Solid	Print a border when using Paper Saver. Note: None is the factory default setting.

Quality menu

Use	To
<p>Print Resolution</p> <p>300 dpi 600 dpi 1200 dpi 1200 Image Q 2400 Image Q</p>	<p>Specify the printed output resolution in dots per inch.</p> <p>Note: 600 dpi is the factory default setting.</p>
<p>Pixel Boost</p> <p>Off Fonts Horizontally Vertically Both directions</p>	<p>Enable more pixels to print in clusters for clarity, in order to enhance images horizontally or vertically, or to enhance fonts.</p> <p>Note: Off is the factory default setting.</p>
<p>Toner Darkness</p> <p>1–10</p>	<p>Lighten or darken the printed output.</p> <p>Notes:</p> <ul style="list-style-type: none"> • 8 is the factory default setting. • Selecting a smaller number can help conserve toner.
<p>Enhance Fine Lines</p> <p>On Off</p>	<p>Enable a print mode preferable for files such as architectural drawings, maps, electrical circuit diagrams, and flow charts.</p> <p>Notes:</p> <ul style="list-style-type: none"> • Off is the factory default setting. • To set this option using the Embedded Web Server, type the network printer IP address in the Web browser address field.
<p>Gray Correction</p> <p>Auto Off</p>	<p>Automatically adjust the contrast enhancement applied to images.</p> <p>Note: Auto is the factory default setting.</p>
<p>Brightness</p> <p>-6 to 6</p>	<p>Adjust the printed output either by lightening or darkening it. You can conserve toner by lightening the output.</p> <p>Note: 0 is the factory default setting.</p>
<p>Contrast</p> <p>0–5</p>	<p>Adjust the contrast of printed objects.</p> <p>Note: 0 is the factory default setting.</p>

Job Accounting menu

Notes:

- This menu appears on the Embedded Web Server only when Upgrade Kit 256MB User Flash (Option:UK-P01) is installed.
- You can maintain the statistics on Job Account by using PageScope Account Manager. PageScope Account Manager (charged) must be installed to be able to maintain the statistics on Job Account, and this machine must be specified as the target device.
- We recommend that you set the administrator password on the Embedded Web Server if you are using the Job Accounting menu.

Use	To
<p>Job Accounting Log</p> <p>On Off</p>	<p>Specify whether to record a received print job.</p> <p>Note: Off is the factory default setting.</p>
<p>Accounting Log Frequency</p> <p>Daily Weekly Monthly</p>	<p>Specify the cycle to update the log file.</p> <p>Notes:</p> <ul style="list-style-type: none"> • Monthly is the factory default setting. • Weekly begins on Monday at 12:00 AM and ends on Sunday at 11:59 PM. • Monthly begins at 12:00 AM on the first day of the month and ends at 11:59 PM on the last day of the month.
<p>Log Action at End of Frequency</p> <p>None Email Current Log Email & Delete Current Log Post Current Log Post & Delete Current Log</p>	<p>Specify how the printer operates at the end of the log file update cycle.</p> <p>Note: None is the factory default setting.</p>
<p>Log Near Full Level</p> <p>Off 1-49</p>	<p>Specify the numeric value by which the printer judges that the log storage area is reaching the upper limit.</p> <p>Notes:</p> <ul style="list-style-type: none"> • 5 is the factory default setting. • The upper limit of the log storage area is 50 MB.

User's Guide

Use	To
<p>Log Action at Near Full</p> <ul style="list-style-type: none"> None Email Current Log Email & Delete Current Log Email & Delete Oldest Log Post Current Log Post & Delete Current Log Post & Delete Oldest Log Delete Current Log Delete Oldest Log Delete All But Current Delete All Logs 	<p>Specify how the printer operates when the log storage area is reaching the upper limit.</p> <p>Note: None is the factory default setting.</p>
<p>Log Action at Full</p> <ul style="list-style-type: none"> None Email & Delete Current Log Email & Delete Oldest Log Post & Delete Current Log Post & Delete Oldest Log Delete Current Log Delete Oldest Log Delete All But Current Delete All Logs 	<p>Specify how the printer operates when the log storage area has reached the upper limit.</p> <p>Note: None is the factory default setting.</p>
<p>URL to Post Logs</p> <p>[user-defined string]</p>	<p>Specify the folder in which to save the job accounting logs.</p> <p>Note: This option is available when "Post Current Log", "Post & Delete Current Log", or "Post & Delete Oldest Log" is selected in Log Action at Near Full/Log Action at Full.</p>
<p>E-mail Address to Send Logs</p> <p>[user-defined string]</p>	<p>Specify the E-mail address to use to send the job accounting logs.</p> <p>Note: This option is available when "E-mail Current Log", "E-mail & Delete Current Log", or "E-mail & Delete Oldest Log" is selected in Log Action at Near Full/Log Action at Full.</p>

User's Guide

Use	To
<p>Log File Prefix</p> <p>[user-defined string]</p>	<p>Change Prefix of the log file.</p> <p>Notes:</p> <ul style="list-style-type: none"> The log file has two naming rules. Ongoing log files appear as "jal_[value of Log File Prefix setting]_current.csv" . Closed log files appear as "jal_[value of Log File Prefix setting]_[time stamp in appropriate Date Format for first day of jobs included in the log].csv" . Current host name string in TCP/IP menu is the factory default setting.
<p>Delete Logs</p> <p>Select All</p> <p>Unselect All</p> <p>Delete</p>	<p>Select the desired log file from the displayed list, and then delete it.</p> <p>Note: This option is displayed only when Job Accounting Log is enabled.</p>
<p>Print/Export Logs</p> <p>Print</p> <p style="padding-left: 20px;">Detailed</p> <p style="padding-left: 20px;">User ID Summary</p> <p style="padding-left: 20px;">Account Code Summary</p> <p>Export</p>	<p>Specify processing of the job accounting log file.</p> <p>Note: This option is displayed only when Job Accounting Log is enabled.</p>

XPS menu

Use	To
<p>Print Error Pages</p> <p>Off</p> <p>On</p>	<p>Print a page containing information on errors, including XML markup errors.</p> <p>Note: Off is the factory default setting.</p>

PostScript menu

Use	To
<p>Print PS Error</p> <p>On Off</p>	<p>Print a page containing the PostScript error.</p> <p>Note: Off is the factory default setting.</p>
<p>Lock PS Startup Mode</p> <p>On Off</p>	<p>Disable the SysStart file.</p> <p>Note: Off is the factory default setting.</p>
<p>Font Priority</p> <p>Resident Flash</p>	<p>Establish the font search order.</p> <p>Notes:</p> <ul style="list-style-type: none"> • Resident is the factory default setting. • This menu item is available only when a formatted flash memory card is installed and operating properly. • Make sure the flash memory card is not read/write-, write-, or password-protected. • Job Buffer Size must not be set to 100%.

Utilities menu

Use	To
<p>Format Flash</p> <p>Yes</p> <p>No</p>	<p>Format the flash memory.</p> <p>Warning—Potential Damage: Do not turn off the printer while the flash memory is being formatted.</p> <p>Notes:</p> <ul style="list-style-type: none"> • Flash memory refers to the memory added by installing a flash memory card in the printer. • Yes deletes all data stored in the flash memory. • No cancels the format request. • The flash memory option card must not be read/write- or write-protected. • This menu item appears only when a non-defective flash memory card is installed.
<p>Activate Hex Trace</p>	<p>Isolate the source of a print job problem.</p> <p>Notes:</p> <ul style="list-style-type: none"> • When activated, all data sent to the printer is printed in hexadecimal and character representation, and control codes are not executed. • To exit or deactivate Hex Trace, restart the printer.
<p>Coverage Estimator</p> <p>Off</p> <p>On</p>	<p>Provide an estimate of the percentage coverage of toner on a page. The estimate is printed on a separate page at the end of each print job.</p> <p>Note: Off is the factory default setting.</p>

PCL Emul menu

Use	To
<p>Font Source</p> <p>Resident Download Flash All</p>	<p>Specify the set of fonts used by the Font Name menu.</p> <p>Notes:</p> <ul style="list-style-type: none"> Resident is the factory default setting. This shows the factory default set of fonts downloaded in the RAM. Download shows all the fonts downloaded in the RAM. Flash shows all fonts resident in that option. The optional flash memory card must be properly formatted and cannot be read/write-, write-, or password-protected. All shows the fonts available to any option.
<p>Font Name</p> <p>Courier 10</p>	<p>Identify a specific font and the option where it is stored.</p> <p>Note: Courier 10 is the factory default setting. This shows the font name, font ID, and the storage location in the printer. The font source abbreviation is R for Resident, F for Flash, and D for Download.</p>
<p>Symbol Set</p> <p>10U PC-8 12U PC-850</p>	<p>Specify the symbol set for each font name.</p> <p>Notes:</p> <ul style="list-style-type: none"> 10U PC-8 is the U.S. factory default setting. 12U PC-850 is the international factory default setting. A symbol set is a set of alphabetic and numeric characters, punctuation, and special symbols. Symbol sets support the different languages or specific program, such as math symbols for scientific text. Only the supported symbol sets are shown.
<p>PCL Emulation Settings</p> <p>Point Size 1.00–1008.00</p>	<p>Change the point size for scalable typographic fonts.</p> <p>Notes:</p> <ul style="list-style-type: none"> 12 is the factory default setting. Point size refers to the height of the characters in the font. One point equals approximately 0.014 inch. Point sizes can be increased or decreased in 0.25-point increments.

User's Guide

Use	To
<p>PCL Emulation Settings</p> <p>Pitch</p> <p>0.08–100</p>	<p>Specify the font pitch for scalable monospaced fonts.</p> <p>Notes:</p> <ul style="list-style-type: none"> • 10 is the factory default setting. • Pitch refers to the number of fixed-space characters per inch (cpi). • Pitch can be increased or decreased in 0.01-cpi increments. • For nonscalable monospaced fonts, the pitch appears on the display but it cannot be changed.
<p>PCL Emulation Settings</p> <p>Orientation</p> <p>Portrait</p> <p>Landscape</p>	<p>Specify the orientation of text and graphics on the page.</p> <p>Notes:</p> <ul style="list-style-type: none"> • Portrait is the factory default setting. Portrait prints text and graphics parallel to the short edge of the page. • Landscape prints text and graphics parallel to the long edge of the page.
<p>PCL Emulation Settings</p> <p>Lines per Page</p> <p>1–255</p>	<p>Specify the number of lines that print on each page.</p> <p>Notes:</p> <ul style="list-style-type: none"> • 60 is the US factory default setting. 64 is the international default setting. • The printer sets the amount of space between each line based on the Lines per Page, Paper Size, and Orientation settings. Select the Paper Size and Orientation you want before setting Lines per Page.
<p>PCL Emulation Settings</p> <p>A4 Width</p> <p>198 mm</p> <p>203 mm</p>	<p>Set the printer to print on A4-size paper.</p> <p>Notes:</p> <ul style="list-style-type: none"> • 198 mm is the factory default setting. • The 203-mm setting sets the width of the page to allow printing of eighty 10-pitch characters.
<p>PCL Emulation Settings</p> <p>Auto CR after LF</p> <p>On</p> <p>Off</p>	<p>Specify whether the printer automatically performs a carriage return (CR) after a line feed (LF) control command.</p> <p>Note: Off is the factory default setting.</p>

User's Guide

Use	To
<p>PCL Emulation Settings</p> <p>Auto LF after CR</p> <p>On</p> <p>Off</p>	<p>Specify whether the printer automatically performs a line feed (LF) after a carriage return (CR) control command.</p> <p>Note: Off is the factory default setting.</p>
<p>Tray Renumber</p> <p>Assign MP Feeder</p> <p>Off</p> <p>None</p> <p>0–199</p> <p>Assign Tray [x]</p> <p>Off</p> <p>None</p> <p>0–199</p> <p>Assign Manual Paper</p> <p>Off</p> <p>None</p> <p>0–199</p> <p>Assign Manual Envelope</p> <p>Off</p> <p>None</p> <p>0–199</p>	<p>Configure the printer to work with printer software or programs that use different source assignments for trays and feeders.</p> <p>Notes:</p> <ul style="list-style-type: none"> • Off is the factory default setting. • None cannot be selected. It is only displayed when it is selected by the PCL 5 interpreter. It also ignores the Select Paper Feed command. • 0–199 allows a custom setting to be assigned.
<p>Tray Renumber</p> <p>View Factory Defaults</p> <p>MPF Default = 8</p> <p>Tray1 Default = 1</p> <p>Tray2 Default = 4</p> <p>Tray3 Default = 5</p> <p>Tray4 Default = 20</p> <p>Tray5 Default = 21</p> <p>Env Default = 6</p> <p>MPaper Default = 2</p> <p>MEnv Default = 3</p>	<p>Display the factory default setting assigned to each tray or feeder.</p>

Use	To
Tray Renumber Restore Defaults Yes No	Restore all tray and feeder assignments to their factory default settings.

Image menu

Use	To
Auto Fit On Off	Select the optimal paper size, scaling, and orientation. Note: On is the factory default setting. It overrides scaling and orientation settings for some images.
Invert On Off	Invert bitonal monochrome images. Notes: <ul style="list-style-type: none"> • Off is the factory default setting. • This setting does not apply to GIF or JPEG images.
Scaling Anchor Top Left Best Fit Anchor Center Fit Height/Width Fit Height Fit Width	Scale the image to fit the selected paper size. Notes: <ul style="list-style-type: none"> • Best Fit is the factory default setting. • When Auto Fit is set to On, Scaling is automatically set to Best Fit.
Orientation Portrait Landscape Reverse Portrait Reverse Landscape	Set the image orientation. Note: Portrait is the factory default setting.

12—Clearing jams

Avoiding jams

Load paper properly

- Make sure paper lies flat in the tray.

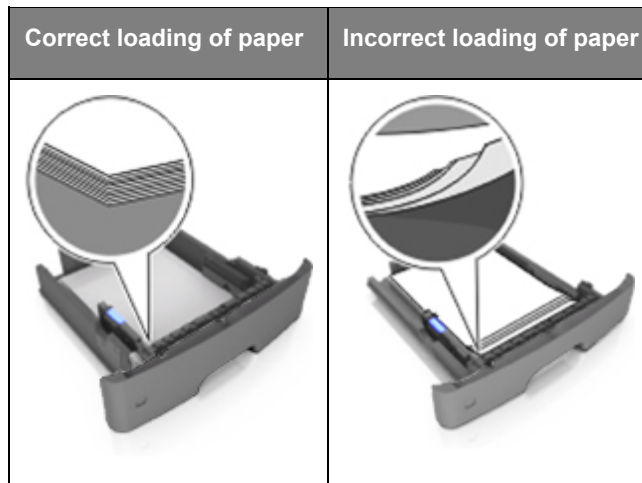

- Do not remove a tray while the printer is printing.
- Do not load a tray while the printer is printing. Load it before printing, or wait for a prompt to load it.
- Do not load too much paper. Make sure the stack height is below the maximum paper fill indicator.
- Do not slide the paper into the tray. Load paper as shown in the illustration.



- Make sure the guides in the tray or the multipurpose feeder are properly positioned and are not pressing tightly against the paper or envelopes.
- Push the tray firmly into the printer after loading paper.

Use recommended paper

- Use only recommended paper or specialty media.
- Do not load wrinkled, creased, damp, bent, or curled paper.
- Flex, fan, and straighten paper before loading it.



- Do not use paper that has been cut or trimmed by hand.
- Do not mix paper sizes, weights, or types in the same tray.
- Make sure the paper size and type are set correctly on the computer or printer control panel.
- Store paper according to manufacturer recommendations.

Understanding jam messages and locations

When a jam occurs, a message indicating the jam location and information to clear the jam appears on the printer display. Open the doors, covers, and trays indicated on the display to remove the jam.

Notes:

- When Jam Assist is set to On, the printer automatically flushes blank pages or pages with partial prints to the standard bin after a jammed page has been cleared. Check your printed output stack for discarded pages.
- When Jam Recovery is set to On or Auto, the printer reprints jammed pages. However, the Auto setting does not guarantee that the page will print.



	Area	Printer control panel message	What to do
1	Standard bin	Jam, standard bin [20y.xx]	Remove the jammed paper.
2	Rear door	Jam, rear door [20y.xx]	Open the rear door, and then remove the jammed paper.
3	Tray 1	Jam, pull tray 1. Push down green flap. [23y.xx]	Pull tray 1 completely out, then push the front duplex flap down, and then remove the jammed paper. Note: You may need to open the rear door to clear some 23y.xx paper jams.
4	Tray [x]	Jam, tray [x] [24y.xx]	Pull the indicated tray out, and then remove the jammed paper.
5	Multipurpose feeder	Jam, MP feeder. [250.xx]	Remove all paper from the multipurpose feeder, and then remove the jammed paper.
6	Front door	Jam, front door. [20y.xx]	Open the front door, and then remove the toner cartridge, imaging unit, and jammed paper.

Jam, front door [20y.xx]

 **CAUTION—HOT SURFACE:** The inside of the printer might be hot. To reduce the risk of injury from a hot component, allow the surface to cool before touching it.

1. Press the button on the right side of the printer, and then open the front door.



2. Pull the toner cartridge out using the handle.

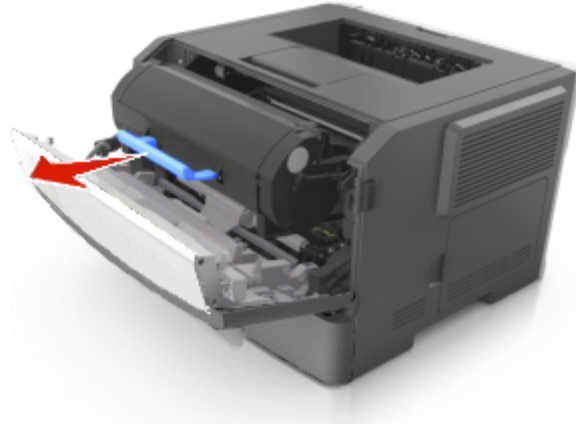

3. Lift the blue handle, and then pull the imaging unit out of the printer.



Warning—Potential Damage: Do not touch the photoconductor drum. Doing so may affect the print quality of future print jobs.

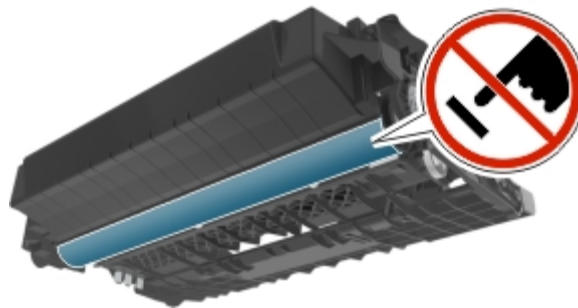

4. Place the imaging unit aside on a flat, smooth surface.

Warning—Potential Damage: Do not expose the imaging unit to direct light for more than 10 minutes. Extended exposure to light can cause print quality problems.

5. Lift the green flap in front of the printer.

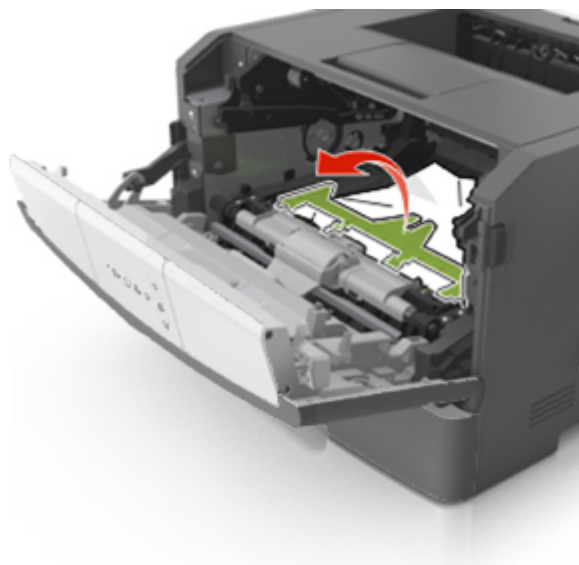

6. Firmly grasp the jammed paper on each side, and then gently pull it out.
Note: Make sure all paper fragments are removed.

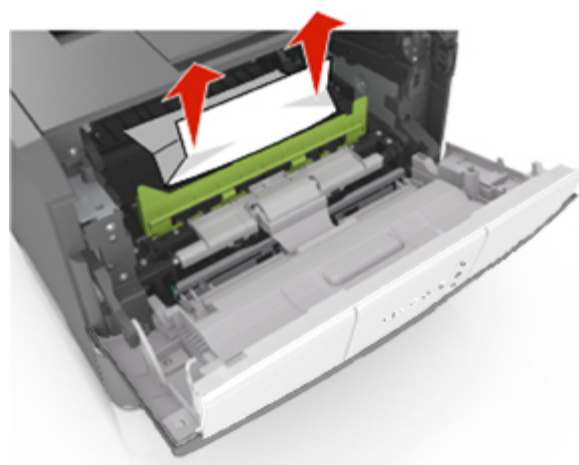

7. Insert the imaging unit by aligning the arrows on the side rails of the unit with the arrows on the side rails inside the printer, and then insert the imaging unit into the printer.

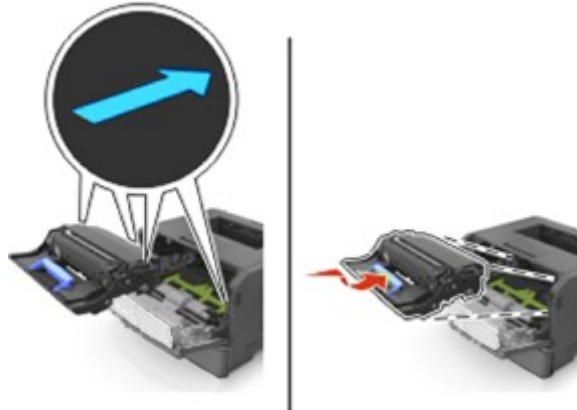

8. Insert the toner cartridge by aligning the side rails of the cartridge with the arrows on the side rails inside the printer, and then insert the cartridge into the printer.

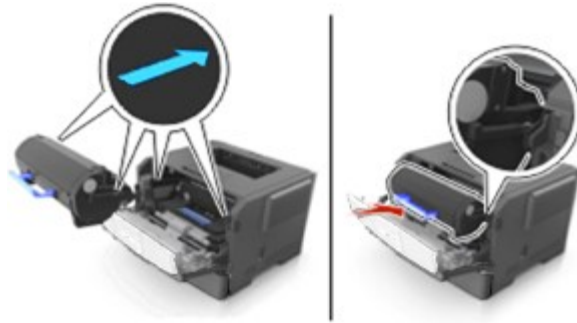

9. Close the front door.

10. From the printer control panel, press to clear the message and continue printing.

Jam, rear door [20y.xx]

1. Press the button on the right side of the printer, and then open the front door.



2. Gently pull down the rear door.

 **CAUTION—HOT SURFACE:** The inside of the printer might be hot. To reduce the risk of injury from a hot component, allow the surface to cool before touching it.



3. Firmly grasp the jammed paper on each side, and then gently pull it out.

Note: Make sure all paper fragments are removed.



4. Close the rear and front doors.

5. From the printer control panel, press  to clear the message and continue printing.

Jam, standard bin [20y.xx]

1. Firmly grasp the jammed paper on each side, and then gently pull it out.

Note: Make sure all paper fragments are removed.



2. From the printer control panel, press  to clear the message and continue printing.

Jam, pull tray 1. Push down green flap. [23y.xx]

1. Pull out the tray completely.



2. Locate the green lever, and then pull it down to release the jam.

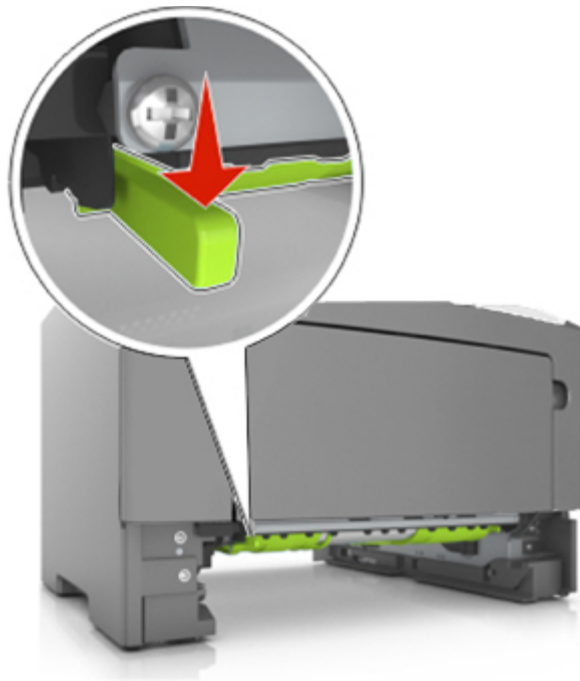

Note: If the jammed paper is not visible in the duplex area, then open the rear door, and then gently remove the jammed paper. Make sure all paper fragments are removed.

3. Firmly grasp the jammed paper on each side, and then gently pull it out.

Note: Make sure all paper fragments are removed.

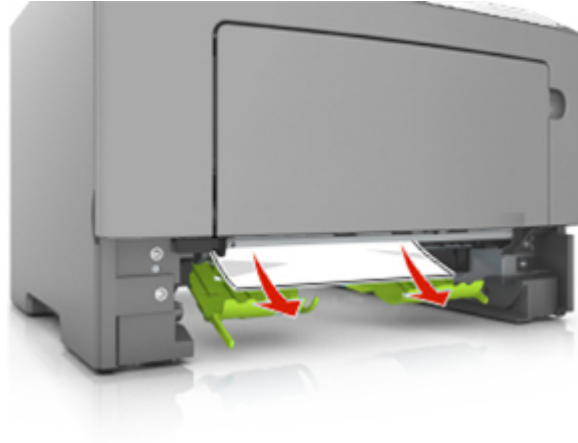

4. Insert the tray.

5. From the printer control panel, press to clear the message and continue printing.

Jam, tray [x] [24y.xx]

1. Pull out the tray completely.

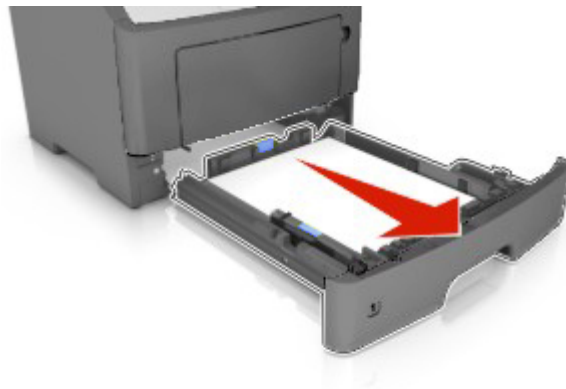

2. Firmly grasp the jammed paper on each side, and then gently pull it out.

Note: Make sure all paper fragments are removed.

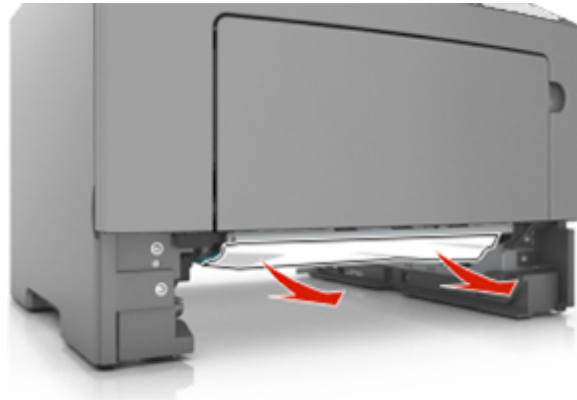

3. Insert the tray.

4. From the printer control panel, press  to clear the message and continue printing.

Jam, MP feeder [250.xx]

1. From the multipurpose feeder, firmly grasp the jammed paper on each side, and then gently pull it out.

Note: Make sure all paper fragments are removed.



2. Flex the sheets of paper back and forth to loosen them, and then fan them. Do not fold or crease the paper. Straighten the edges on a level surface.



3. Reload paper into the multipurpose feeder.

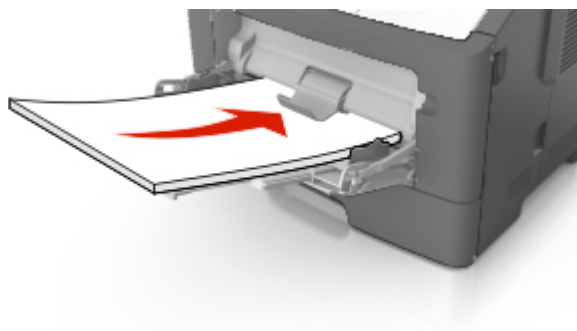

Note: Make sure the paper guide lightly rests against the edge of the paper.

4. From the printer control panel, press to clear the message and continue printing.

13—Maintaining the printer

Warning—Potential Damage: Failure to maintain optimum printer performance, or to replace parts and supplies, may cause damage to your printer.

Cleaning the printer

Note: You may need to perform this task after every few months.

Warning—Potential Damage: Damage to the printer caused by improper handling is not covered by the printer warranty.

1. Make sure that the printer is turned off and unplugged from the electrical outlet.



CAUTION—SHOCK HAZARD: To avoid the risk of electrical shock when cleaning the exterior of the printer, unplug the power cord from the electrical outlet and disconnect all cables from the printer before proceeding.

2. Remove paper from the standard bin and multipurpose feeder.
3. Remove any dust, lint, and pieces of paper around the printer using a soft brush or vacuum.
4. Dampen a clean, lint-free cloth with water, and use it to wipe the outside of the printer.

Warning—Potential Damage: Do not use household cleaners or detergents to prevent damage to the exterior of the printer.

5. Make sure all areas of the printer are dry before sending a new print job.

Checking the status of parts and supplies

Using the Embedded Web Server

1. Open a Web browser, and then type the printer IP address in the address field.

Notes:

- View the printer IP address in the TCP/IP section in the Network/Ports menu. The IP address appears as four sets of numbers separated by periods, such as 123.123.123.123.
- If you are using a proxy server, then temporarily disable it to load the Web page correctly.

2. Click **Device Status**.

Using the control panel

From the printer control panel, navigate to:



Estimated number of remaining pages

The estimated number of remaining pages is based on the recent printing history of the printer. Its accuracy may vary significantly and is dependent on many factors, such as actual document content, print quality settings, and other printer settings.

The accuracy of the estimated number of remaining pages may decrease when the actual printing consumption is different from the historical printing consumption. Consider the variable level of accuracy before purchasing or replacing supplies based on the estimate. Until an adequate print history is obtained on the printer, initial estimates assume future supplies consumption based on the International Organization for Standardization* test methods and page content.

* Average continuous black declared cartridge yield in accordance with ISO/IEC 19752.

Ordering supplies

Using genuine KONICA MINOLTA parts and supplies

Your KONICA MINOLTA printer is designed to function best with genuine KONICA MINOLTA supplies and parts. Use of third-party supplies or parts may affect the performance, reliability, or life of the printer and its imaging components. Use of third-party supplies or parts can affect warranty coverage. Damage caused by the use of third-party supplies or parts is not covered by the warranty. All life indicators are designed to function with KONICA MINOLTA supplies and parts, and may deliver unpredictable results if third-party supplies or parts are used. Imaging component usage beyond the intended life may damage your KONICA MINOLTA printer or its associated components.

Ordering toner cartridges

Notes:

- The estimated cartridge yield is based on the ISO/IEC 19752 standard.
- Extremely low print coverage for extended periods of time may reduce the actual yield.

Part name	Part number
For the United States, Latin America (120v) and Taiwan	
Toner Cartridge 10K for bizhub 3301P (Use and Return)	A63V 00F
Toner Cartridge 10K for bizhub 3301P	A63V 00W
For Europe	
Toner Cartridge 10K for bizhub 3301P (Use and Return)	A63V 00H
Toner Cartridge 10K for bizhub 3301P	A63V 00W

Part name	Part number
For the Asia Pacific, Africa, Middle East, Latin America (220v), Australia and New Zealand	
Toner Cartridge 10K for bizhub 3301P (Use and Return)	A63V 00K
Toner Cartridge 10K for bizhub 3301P	A63V 00W
For China	
Toner Cartridge 10K for bizhub 3301P (Use and Return)	A63V 00K
Toner Cartridge 10K for bizhub 3301P	A63V 00R

Ordering an imaging unit

Extremely low print coverage for extended periods of time may cause imaging unit parts to fail prior to exhaustion of toner from toner cartridge.

For more information on replacing the imaging unit, see the instruction sheet that came with the supply.

Part name	Destination	Part number
Imaging unit 60K for bizhub 3301P (Use and Return)	For World wide	A63X 03V
Imaging unit 60K for bizhub 3301P	For World wide	A63X 03W

Storing supplies

Choose a cool, clean storage area for the printer supplies. Store supplies right side up in their original packing until you are ready to use them.

Do not expose supplies to:

- Direct sunlight
- Temperatures above 35°C (95°F)
- High humidity above 80%
- Salty air
- Corrosive gases
- Heavy dust

Replacing supplies

Replacing the toner cartridge

1. Press the button on the right side of the printer, and then open the front door.



2. Pull the toner cartridge out using the handle.



3. Unpack the toner cartridge, and then remove all packing materials.
4. Shake the new cartridge to redistribute the toner.



5. Insert the toner cartridge into the printer by aligning the side rails of the cartridge with the arrows on the side rails inside the printer.

Warning—Potential Damage: Do not expose the imaging unit to direct light for more than 10 minutes. Extended exposure to light may cause print quality problems.

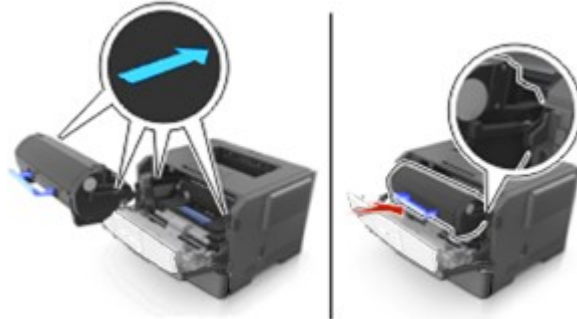

6. Close the front door.

Note: Dispose of the empty toner cartridge according to your local regulations. Do not burn the toner cartridge.

CAUTION: If you get toner in your eyes, wash it out immediately with cool water and consult a doctor.

Replacing the imaging unit

1. Press the button on the right side of the printer, and then open the front door.



2. Pull the toner cartridge out using the handle.

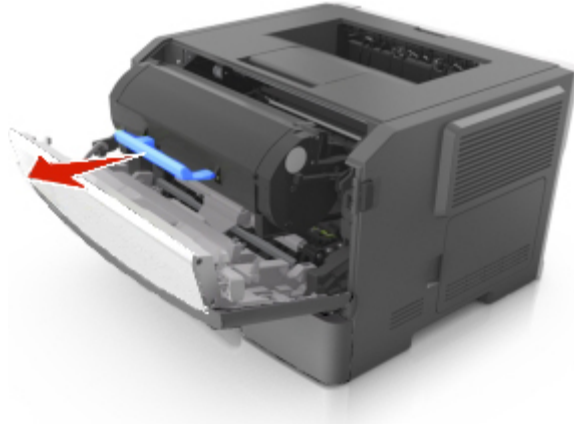

3. Lift the blue handle, and then pull the imaging unit out of the printer.



4. Unpack the new imaging unit, and then shake it.

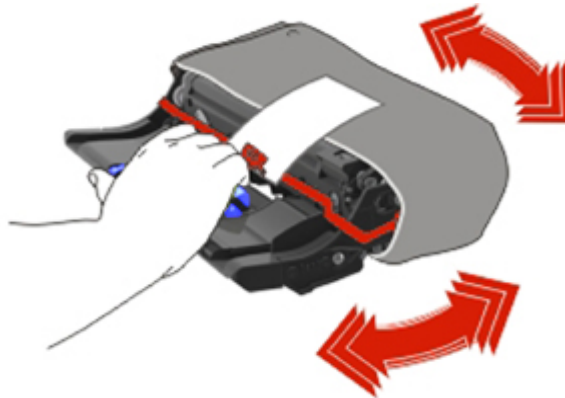

5. Remove all packing materials from the imaging unit.

Warning—Potential Damage: Do not expose the imaging unit to direct light for more than 10 minutes. Extended exposure to light may cause print quality problems.

Warning—Potential Damage: Do not touch the photoconductor drum. Doing so may affect the print quality of future print jobs.

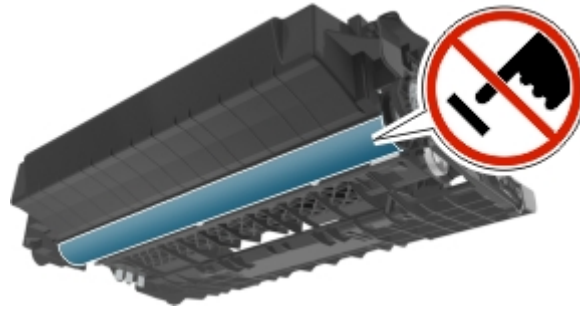

6. Insert the imaging unit into the printer by aligning the arrows on the side rails of the imaging unit with the arrows on the side rails inside the printer.

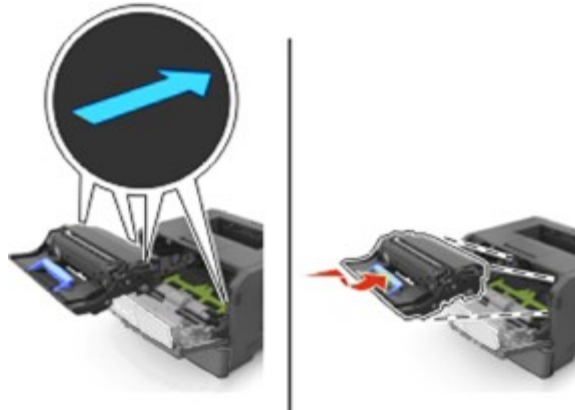

7. Insert the toner cartridge into the printer by aligning the side rails of the cartridge with the arrows on the side rails inside the printer.

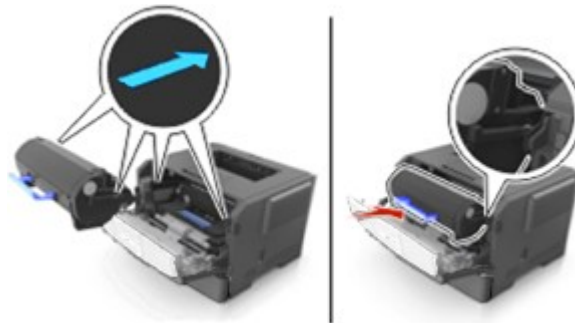

8. Close the front door.

Note: Dispose of the used imaging unit according to your local regulations. Do not burn the imaging unit.

Moving the printer

Before moving the printer

⚠ CAUTION—POTENTIAL INJURY: Before moving the printer, follow these guidelines to avoid personal injury or printer damage:

- Turn the printer off using the power switch, and then unplug the power cord from the electrical outlet.
- Disconnect all cords and cables from the printer before moving it.
- If an optional tray is installed, then remove it from the printer. To remove the optional tray, slide the latch on the right side of the tray toward the front of the tray until it *clicks* into place.



- Use the handholds located on both sides of the printer to lift it.
- Make sure your fingers are not under the printer when you set it down.
- Before setting up the printer, make sure there is adequate clearance around it.

Use only the power cord provided with this product or the manufacturer's authorized replacement.

Warning—Potential Damage: Damage to the printer caused by improper moving is not covered by the printer warranty.

Moving the printer to another location

The printer and its hardware options can be safely moved to another location by following these precautions:

- Any cart used to move the printer must have a surface able to support the full footprint of the printer.
- Any cart used to move the hardware options must have a surface able to support the dimensions of the hardware options.
- Keep the printer in an upright position.
- Avoid severe jarring movements.

Shipping the printer

When shipping the printer, use the original packaging or call the place of purchase for a relocation kit.

14—Troubleshooting

Understanding the printer messages

Bin full. Remove paper.

Remove the paper stack from the standard bin.

Cannot collate large document [37]







Try one or more of the following:

- From the printer control panel, press  to print the portion of the job already stored and begin collating the rest of the print job.
- Cancel the current print job.

Cannot defrag flash memory [37]

Try one or more of the following:

- From the printer control panel, press  to stop the defragmentation and continue printing.
- Delete fonts, macros, and other data in the printer memory. From the printer control panel, navigate to:

 >Settings >  >Print Settings >  >Utilities Menu >  >Format Flash > 
>Yes > 

- Install additional printer memory.

Change [paper source] to [custom string]. Load [orientation].

Try one or more of the following:

- Load the correct size and type of paper in the tray, and then press  on the control panel.
Note: Make sure the paper size and type settings are specified in the Paper menu on the control panel.
- Select **Use current [paper source]** on the control panel to clear the message and continue printing using the current size and type of paper in the tray.
- Cancel the print job.

Change [paper source] to [custom type name]. Load [orientation].

Try one or more of the following:

- Load the correct size and type of paper in the tray, and then press  on the control panel.
Note: Make sure the paper size and type settings are specified in the Paper menu on the control panel.
- Select **Use current [paper source]** on the control panel to clear the message and continue printing using the current size and type of paper in the tray.
- Cancel the print job.

Change [paper source] to [paper size]. Load [orientation].

Try one or more of the following:

- Load the correct size and type of paper in the tray, and then press  on the control panel.
Note: Make sure the paper size and type settings are specified in the Paper menu on the control panel.
- Select **Use current [paper source]** on the control panel to clear the message and continue printing using the current size and type of paper in the tray.
- Cancel the print job.

Change [paper source] to [paper type] [paper size]. Load [orientation].

Try one or more of the following:

- Load the correct size and type of paper in the tray, and then press  on the control panel.
Note: Make sure the paper size and type settings are specified in the Paper menu on the control panel.
- Select **Use current [paper source]** on the control panel to clear the message and continue printing using the current size and type of paper in the tray.
- Cancel the print job.

Complex page may misprint [39]

Try one or more of the following:

- From the printer control panel, press  to clear the message and continue printing.
- Reduce the number and size of fonts, the number and complexity of images, and the number of pages in the print job.

- Cancel the print job.
- Install additional printer memory.

Defective flash memory [51]



Try one or more of the following:

- Replace the defective flash memory card.
- From the printer control panel, press  to ignore the message and continue printing.
- Cancel the current print job.

Flash memory full [52]

Try one or more of the following:

- From the printer control panel, press  to clear the message and continue printing.
- Delete fonts, macros, and other data stored in the flash memory. From the printer control panel, navigate to:

 > **Settings** >  > **Print Settings** >  > **Utilities Menu** >  > **Format Flash** > 
> **Yes** > 

- Use a larger-capacity flash memory card.

Note: Downloaded fonts and macros that are not stored in the flash memory are deleted when the printer is powered off or restarted.

Flash memory unformatted [53]

Try one or more of the following:

- From the printer control panel, press  to stop the defragmentation and continue printing.
- Format the flash memory device.

Note: If the error message remains, then the flash memory device may be defective and need to be replaced.

Load MP feeder with [custom type name] [orientation]

Try one or more of the following:

- Load the feeder with the correct size and type of paper.

- From the printer control panel, press  to clear the message and continue printing.
Note: If no paper is loaded in the feeder, then the printer manually overrides the request, and then prints from an automatically selected tray.
- Cancel the current job.

Load MP feeder with [custom string] [orientation]

Try one or more of the following:

- Load the feeder with the correct size and type of paper.
- From the printer control panel, press  to clear the message and continue printing.
Note: If no paper is loaded in the feeder, then the printer manually overrides the request, and then prints from an automatically selected tray.
- Cancel the current job.

Load MP feeder with [paper size] [orientation]

Try one or more of the following:

- Load the feeder with the correct size of paper.
- From the printer control panel, press  to clear the message and continue printing.
Note: If no paper is loaded in the feeder, then the printer manually overrides the request, and then prints from an automatically selected tray.
- Cancel the current job.

Load MP feeder with [paper type] [paper size] [orientation]

Try one or more of the following:

- Load the feeder with the correct size and type of paper.
- From the printer control panel, press  to clear the message and continue printing.
Note: If no paper is loaded in the feeder, then the printer manually overrides the request, and then prints from an automatically selected tray.
- Cancel the current job.

Memory low, no Resource Save [35]

Try one or more of the following:

- From the printer control panel, press  to disable Resource Save, clear the message, and continue printing.
- Install additional printer memory.

Non-Printer Manufacturer [supply type], see User's Guide [33.xy]



Note: The supply type can either be a toner cartridge or imaging unit.

The printer has detected a non-Printer Manufacturer supply or part installed in the printer.

Your KONICA MINOLTA printer is designed to function best with genuine Printer Manufacturer supplies and parts. Use of third-party supplies or parts may affect the performance, reliability, or life of the printer and its imaging components.

All life indicators are designed to function with Printer Manufacturer supplies and parts, and may deliver unpredictable results if third-party supplies or parts are used. Imaging component usage beyond the intended life may damage your KONICA MINOLTA printer or associated components.

Warning—Potential Damage: Use of third-party supplies or parts can affect warranty coverage. Damage caused by the use of third-party supplies or parts are not covered by the warranty.

To accept any and all of these risks and to proceed with the use of non-genuine supplies or parts in your printer, press  and  on the printer control panel simultaneously for 15 seconds to clear the message and continue printing.

If you do not wish to accept these risks, then remove the third-party supply or part from your printer, and then install a genuine KONICA MINOLTA supply or part.

Note: For the list of supported supplies, see the “Ordering supplies” section of the *User's Guide*.

Network error, port [x] [54]

Try one or more of the following:

- From the printer control panel, press  to clear the message and continue printing.
- Unplug the router, wait for 30 seconds, and then plug it back again.
- Turn off the printer, wait for about 10 seconds, and then turn the printer back on.
- Update the network firmware in the printer or the print server.

Network error, standard port [54]

Try one or more of the following:

- From the printer control panel, press  to clear the message and continue printing.
- Unplug the router, wait for 30 seconds, and then plug it back again.
- Turn off the printer, wait for about 10 seconds, and then turn the printer back on.
- Update the network firmware in the printer or the print server.

Paper too short [34]

Try one or more of the following:

- Load the correct size of paper in the tray.
- From the printer control panel, press  to clear the message and print using a different tray.
- Check the tray length and width guides and make sure the paper is loaded properly in the tray.
- Make sure the correct paper size and type are specified in Print Properties or in the Print dialog.
- Make sure the paper size and type settings are specified in the Paper menu on the printer control panel.
- Make sure the paper size is correctly set. For example, if the MP Feeder Size is set to Universal, then make sure the paper is large enough for the data being printed.
- Cancel the print job.

Parallel port disabled [56]

Try one or more of the following:

- From the printer control panel, press  to clear the message and continue printing.
Note: The printer discards any data received through the parallel port.
- From the printer control panel, set Parallel Buffer to Auto.

Printer restart. Check last job.

Press  on the printer control panel to clear the message and continue printing.

Rear USB port disabled [56]

Try one or more of the following:

- From the printer control panel, press  to clear the message and continue printing.

Note: The printer discards any data received through the USB port.

- From the printer control panel, set USB Buffer to Auto.

Too many trays. Remove some. [58]

- Turn off the printer.
- Unplug the power cord from the electrical outlet.
- Remove the extra trays.
- Connect the power cord to the electrical outlet.
- Turn the printer back on.

Solving printer problems

- [Basic printer problems](#)
- [Option problems](#)
- [Paper feed problems](#)

Basic printer problems

The printer is not responding

Action	Yes	No
<p>Step 1</p> <p>Make sure the printer is turned on.</p> <p>Is the printer turned on?</p>	Go to step 2.	Turn on the printer.

User's Guide

Action	Yes	No
<p>Step 2</p> <p>Check if the printer is in Sleep mode or Hibernate mode.</p> <p>Is the printer in Sleep mode or Hibernate mode?</p>	<p>Press the Sleep button to wake the printer from Sleep mode or Hibernate mode.</p>	<p>Go to step 3.</p>
<p>Step 3</p> <p>Check if one end of the power cord is plugged into the printer and the other to a properly grounded electrical outlet.</p> <p>Is the power cord plugged into the printer and a properly grounded electrical outlet?</p>	<p>Go to step 4.</p>	<p>Plug one end of the power cord into the printer and the other to a properly grounded electrical outlet.</p>
<p>Step 4</p> <p>Check other electrical equipment plugged into the electrical outlet.</p> <p>Does other electrical equipment work?</p>	<p>Unplug the other electrical equipment, and then turn on the printer. If the printer does not work, then reconnect the other electrical equipment.</p>	<p>Go to step 5.</p>
<p>Step 5</p> <p>Check if the cables connecting the printer and the computer are inserted in the correct ports.</p> <p>Are the cables inserted in the correct ports?</p>	<p>Go to step 6.</p>	<p>Make sure to match the following:</p> <ul style="list-style-type: none"> • The USB symbol on the cable with the USB symbol on the printer • The appropriate Ethernet cable with the Ethernet port
<p>Step 6</p> <p>Make sure the electrical outlet is not turned off by a switch or breaker.</p> <p>Is the electrical outlet turned off by a switch or breaker?</p>	<p>Turn on the switch or reset the breaker.</p>	<p>Go to step 7.</p>

User's Guide

Action	Yes	No
<p>Step 7</p> <p>Check if the printer is plugged into any surge protectors, uninterruptible power supplies, or extension cords.</p> <p>Is the printer plugged into any surge protectors, uninterruptible power supplies, or extension cords?</p>	<p>Connect the printer power cord directly to a properly grounded electrical outlet.</p>	<p>Go to step 8.</p>
<p>Step 8</p> <p>Check if one end of the printer cable is plugged into a port on the printer and the other to the computer, print server, option, or other network device.</p> <p>Is the printer cable securely attached to the printer and the computer, print server, option, or other network device?</p>	<p>Go to step 9.</p>	<p>Connect the printer cable securely to the printer and the computer, print server, option, or other network device.</p>
<p>Step 9</p> <p>Make sure to install all hardware options properly and remove any packing material.</p> <p>Are all hardware options properly installed and all packing material removed?</p>	<p>Go to step 10.</p>	<p>Turn off the printer, remove all packing materials, then reinstall the hardware options, and then turn on the printer.</p>
<p>Step 10</p> <p>Check if you have selected the correct port settings in the printer driver.</p> <p>Are the port settings correct?</p>	<p>Go to step 11.</p>	<p>Use correct printer driver settings.</p>
<p>Step 11</p> <p>Check the installed printer driver.</p> <p>Is the correct printer driver installed?</p>	<p>Go to step 12.</p>	<p>Install the correct printer driver.</p>

Action	Yes	No
<p>Step 12</p> <p>Turn off the printer, then wait for about 10 seconds, and then turn the printer back on.</p> <p>Is the printer working?</p>	The problem is solved.	Contact technical support .

Printer display is blank

Action	Yes	No
<p>Step 1</p> <p>Press the Sleep button on the printer control panel.</p> <p>Does Ready appear on the printer display?</p>	The problem is solved.	Go to step 2.
<p>Step 2</p> <p>Turn off the printer, then wait for about 10 seconds, and then turn the printer back on.</p> <p>Do Please wait and Ready appear on the printer display?</p>	The problem is solved.	Turn off the printer, and then contact technical support .

Option problems

Cannot detect internal option

Action	Yes	No
<p>Step 1</p> <p>Turn off the printer, then wait for about 10 seconds, and then turn on the printer.</p> <p>Does the internal option operate correctly?</p>	The problem is solved.	Go to step 2.

User's Guide

Action	Yes	No
<p>Step 2</p> <p>Check if the internal option is properly installed in the controller board.</p> <ol style="list-style-type: none"> 1. Turn off the printer using the power switch, and then unplug the power cord from the electrical outlet. 2. Make sure the internal option is installed in the appropriate connector in the controller board. 3. Connect the power cord to the printer, then to a properly grounded electrical outlet, and then turn on the printer. <p>Is the internal option properly installed in the controller board?</p>	<p>Go to step 3.</p>	<p>Connect the internal option to the controller board.</p>
<p>Step 3</p> <p>Print a menu settings page, and then check to see if the internal option is listed in the Installed Features list.</p> <p>Is the internal option listed in the menu settings page?</p>	<p>Go to step 4.</p>	<p>Reinstall the internal option.</p>
<p>Step 4</p> <ol style="list-style-type: none"> 1. Check if the internal option is selected. <p>It may be necessary to manually add the internal option in the printer driver to make it available for print jobs. For more information, see Adding available options in the printer driver.</p> <ol style="list-style-type: none"> 2. Resend the print job. <p>Does the internal option operate correctly?</p>	<p>The problem is solved.</p>	<p>Contact technical support.</p>

Tray problems

Action	Yes	No
<p>Step 1</p> <p>1. Open the tray and do one or more of the following:</p> <ul style="list-style-type: none"> - Check for paper jams or misfeeds. - Check if the paper size indicators on the paper guides are aligned with the paper size indicators on the tray. - If you are printing on custom-size paper, then make sure that the paper guides rest against the edges of the paper. - Make sure the paper is below the maximum paper fill indicator. - Make sure paper lies flat in the tray. <p>2. Check if the tray closes properly.</p> <p>Is the tray working?</p>	<p>The problem is solved.</p>	<p>Go to step 2.</p>
<p>Step 2</p> <p>1. Turn off the printer, then wait about 10 seconds, and then turn the printer back on.</p> <p>2. Resend the print job.</p> <p>Is the tray working?</p>	<p>The problem is solved.</p>	<p>Go to step 3.</p>

User's Guide







Action	Yes	No
<p>Step 3</p> <p>Check if the tray is installed and recognized by the printer.</p> <p>Print a menu settings page, and then check if the tray is listed in the Installed Features list.</p> <p>Is the tray listed in the menu settings page?</p>	<p>Go to step 4.</p>	<p>Reinstall the tray. For more information, see the setup documentation that came with the tray.</p>
<p>Step 4</p> <p>Check if the tray is available in the printer driver.</p> <p>Note: If necessary, manually add the tray in the printer driver to make it available for print jobs. For more information, see Adding available options in the printer driver.</p> <p>Is the tray available in the printer driver?</p>	<p>Go to step 5.</p>	<p>Manually add the tray in the printer driver.</p>
<p>Step 5</p> <p>Check if the option is selected.</p> <ol style="list-style-type: none"> From the application you are using, select the option. For Mac OS X version 9 users, make sure the printer is set up in Chooser. Resend the print job. <p>Is the tray working?</p>	<p>The problem is solved.</p>	<p>Contact technical support.</p>

Paper feed problems

Paper jam message remains after jam is cleared

Action	Yes	No
<p>Open front door and remove all trays.</p> <p>1. Clear any jammed pages.</p> <p>Note: Make sure all paper fragments are removed.</p> <p>2. Press  to clear the message and continue printing.</p> <p>Does the paper jam message remain?</p>	<p>Contact technical support.</p>	<p>The problem is solved.</p>

Jammed pages are not reprinted

Action	Yes	No
<p>1. Turn on jam recovery.</p> <p>a. From the printer control panel, navigate to:</p> <p> >Settings >  >General Settings >  >Print Recovery >  >Jam Recovery > </p> <p>b. Press the arrow buttons until On or Auto appears, and then press .</p> <p>2. Resend the pages that did not print.</p> <p>Were the jammed pages reprinted?</p>	<p>The problem is solved.</p>	<p>Contact technical support.</p>

Solving print problems

Printing problems

Print jobs do not print

Action	Yes	No
<p>Step 1</p> <ol style="list-style-type: none"> From the document you are trying to print, open the Print dialog and check if you have selected the correct printer. <p>Note: If the printer is not the default printer, then you must select the printer for each document that you want to print.</p> <ol style="list-style-type: none"> Resend the print job. <p>Do the jobs print?</p>	The problem is solved.	Go to step 2.
<p>Step 2</p> <ol style="list-style-type: none"> Check if the printer is plugged in and turned on, and if Ready appears on the printer display. Resend the print job. <p>Do the jobs print?</p>	The problem is solved.	Go to step 3.
<p>Step 3</p> <p>If an error message appears on the printer display, then clear the message.</p> <p>Note: The printer continues to print after clearing the message.</p> <p>Do the jobs print?</p>	The problem is solved.	Go to step 4.
<p>Step 4</p> <ol style="list-style-type: none"> Check if the ports (USB, serial, or Ethernet) are working and if the cables are securely connected to the computer and the printer. <p>Note: For more information, see the setup documentation that came with the printer.</p> <ol style="list-style-type: none"> Resend the print job. <p>Do the jobs print?</p>	The problem is solved.	Go to step 5.

Action	Yes	No
<p>Step 5</p> <ol style="list-style-type: none"> 1. Turn off the printer, then wait for about 10 seconds, and then turn the printer back on. 2. Resend the print job. <p>Do the jobs print?</p>	The problem is solved.	Go to step 6.
<p>Step 6</p> <ol style="list-style-type: none"> 1. Remove, and then reinstall the printer driver. For more information, see Installing the printer driver. 2. Resend the print job. <p>Do the jobs print?</p>	The problem is solved.	Contact technical support .

Printing slows down

Notes:

- When printing using narrow paper, the printer prints at a reduced speed to prevent damage to the fuser.
- The printer speed may be reduced when printing for long periods of time, or printing at elevated temperatures.
- The printer speed may also be reduced when the printed output resolution is set to 1,200 dpi.

Action	Yes	No
<p>Place letter- or A4-size paper in the tray, and then resend the print job.</p> <p>Does the print speed increase?</p>	The problem is solved.	Contact technical support .

Job prints from the wrong tray or on the wrong paper

Action	Yes	No
<p>Step 1</p> <ol style="list-style-type: none"> 1. Check if you are printing on paper that is supported by the tray. 2. Resend the print job. <p>Did the job print from the correct tray or on the correct paper?</p>	The problem is solved.	Go to step 2.
<p>Step 2</p> <ol style="list-style-type: none"> 1. From the Paper menu on the printer control panel, set the paper size and type to match the paper loaded in the tray. 2. Resend the print job. <p>Did the job print from the correct tray or on the correct paper?</p>	The problem is solved.	Go to step 3.
<p>Step 3</p> <ol style="list-style-type: none"> 1. Depending on your operating system, open Printing Preferences or the Print dialog, and then specify the paper type. 2. Resend the print job. <p>Did the job print from the correct tray or on the correct paper?</p>	The problem is solved.	Go to step 4.
<p>Step 4</p> <ol style="list-style-type: none"> 1. Check if the trays are not linked. 2. Resend the print job. <p>Did the job print from the correct tray or on the correct paper?</p>	The problem is solved.	Contact technical support .

Incorrect characters print

Action	Yes	No
<p>Step 1</p> <p>Make sure the printer is not in Hex Trace mode.</p> <p>Note: If Ready Hex appears on the printer display, then turn off the printer, and then turn it back on to deactivate Hex Trace mode.</p> <p>Is the printer in Hex Trace mode?</p>	Deactivate Hex Trace mode.	Go to step 2.
<p>Step 2</p> <ol style="list-style-type: none"> From the printer control panel, select Standard Network or Network [x], and then set SmartSwitch to On. Resend the print job. <p>Do incorrect characters print?</p>	Contact technical support .	The problem is solved.

Tray linking does not work

Note: The trays and the multipurpose feeder do not automatically detect the paper size. You must set the size from the Paper Size/Type menu.

Action	Yes	No
<ol style="list-style-type: none"> From the printer control panel, set the paper size and type in the Paper menu to match the paper loaded in the trays to be linked. <p>Note: The paper size and type must match for trays to be linked.</p> <ol style="list-style-type: none"> Resend the print job. <p>Do the trays link correctly?</p>	The problem is solved.	Contact technical support .

Large jobs do not collate











Action	Yes	No
<p>Step 1</p> <ol style="list-style-type: none"> From the Finishing menu on the printer control panel, set Collate to (1,2,3) (1,2,3). Resend the print job. <p>Did the job print and collate correctly?</p>	<p>The problem is solved.</p>	<p>Go to step 2.</p>
<p>Step 2</p> <ol style="list-style-type: none"> From the printer software, set Collate to (1,2,3) (1,2,3). <p>Note: Setting Collate to (1,1,1) (2,2,2) in the software overrides the setting in the Finishing menu.</p> <ol style="list-style-type: none"> Resend the print job. <p>Did the job print and collate correctly?</p>	<p>The problem is solved.</p>	<p>Go to step 3.</p>
<p>Step 3</p> <p>Reduce the complexity of the print job by eliminating the number and size of fonts, the number and complexity of images, and the number of pages in the job.</p> <p>Did the job print and collate correctly?</p>	<p>The problem is solved.</p>	<p>Contact technical support.</p>

Unexpected page breaks occur

Action	Yes	No
<p>Step 1</p> <p>Adjust the print timeout settings.</p> <ol style="list-style-type: none"> From the printer control panel, navigate to: Settings >General Settings >Timeouts >Print Timeout Select a higher setting and then, depending on your printer model, select  or Submit. Resend the print job. <p>Did the file print correctly?</p>	The problem is solved.	Go to step 2.
<p>Step 2</p> <ol style="list-style-type: none"> Check the original file for manual page breaks. Resend the print job. <p>Did the file print correctly?</p>	The problem is solved.	Contact technical support .

Print job takes longer than expected

Action	Yes	No
<p>Step 1</p> <p>Reduce the number and size of fonts, the number and complexity of images, and the number of pages in the print job, and then resend the print job.</p> <p>Does the print job still take long?</p>	Go to step 2.	The problem is solved.

Action	Yes	No
<p>Step 2</p> <p>Disable the Page Protect feature.</p> <p>From the printer control panel, navigate to:</p> <p> >Settings >  >General Settings >  >Print Recovery >  >Page Protect >  >Off > </p> <p>Does the print job still take long?</p>	<p>Go to step 3.</p>	<p>The problem is solved.</p>
<p>Step 3</p> <p>Change the environmental settings.</p> <p>From the printer control panel, navigate to:</p> <p> >Settings >  >General Settings >  >Eco-Mode > select a setting > </p> <p>Note: When using the Eco-Mode setting, you may notice a reduction in performance.</p> <p>Does the print job still take long?</p>	<p>Install additional printer memory.</p>	<p>The problem is solved.</p>

Confidential and other held jobs do not print

Note: Confidential, Verify, Reserve, and Repeat print jobs may be deleted if the printer requires extra memory to process additional held jobs.

Action	Yes	No
<p>Step 1</p> <p>Open the held jobs folder on the display, and then verify that your print job is listed.</p> <p>Is your print job listed in the held jobs folder?</p>	<p>Go to step 2.</p>	<p>Select one of the Print and Hold options, and then resend the print job.</p>

Action	Yes	No
<p>Step 2</p> <p>The print job may contain a formatting error or invalid data.</p> <ul style="list-style-type: none"> Delete the print job, and then send it again. For PDF files, generate a new PDF, and then print it again. <p>If you are printing from the Internet, then the printer may be reading multiple job titles as duplicates and deleting all jobs except the first one.</p> <p>For Macintosh users</p> <p>Save each print job, name each job differently, and then send the individual jobs to the printer.</p> <p>Does the job print?</p>	<p>The problem is solved.</p>	<p>Go to step 3.</p>
<p>Step 3</p> <p>Free up additional printer memory by deleting some of the held jobs.</p> <p>Does the job print?</p>	<p>The problem is solved.</p>	<p>Add additional printer memory.</p>

Print job takes longer than expected

Action	Yes	No
<p>Step 1</p> <p>Change the environmental settings of the printer.</p> <ol style="list-style-type: none"> From the control panel, navigate to: Settings >General Settings Select Eco-Mode or Quiet Mode, and then select Off. <p>Note: Disabling Eco-Mode or Quiet Mode may increase the consumption of energy or supplies, or both.</p> <p>Did the job print?</p>	<p>The problem is solved.</p>	<p>Go to step 2.</p>

Action	Yes	No
<p>Step 2</p> <p>Reduce the font size, the number and complexity of images, and the number of pages in the print job, and then resend the job</p> <p>Did the job print?</p>	The problem is solved.	Go to step 3.
<p>Step 3</p> <ol style="list-style-type: none"> 1. Remove held jobs stored in the printer memory. 2. Resend the print job. <p>Did the job print?</p>	The problem is solved.	Go to step 4.
<p>Step 4</p> <ol style="list-style-type: none"> 1. Disable the Page Protect feature. <p>From the control panel, navigate to: Settings >General Settings >Print Recovery >Page Protect >Off</p> <ol style="list-style-type: none"> 2. Resend the print job. <p>Did the job print?</p>	The problem is solved.	Go to step 5.
<p>Step 5</p> <p>Install additional printer memory, and then resend the print job.</p> <p>Did the job print?</p>	The problem is solved.	Contact technical support .

Print quality problems

Clipped pages or images

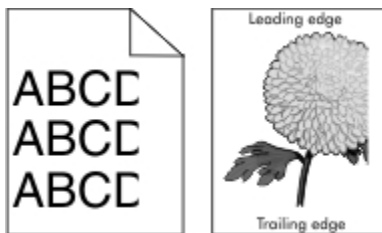

User's Guide

Action	Yes	No
<p>Step 1</p> <ol style="list-style-type: none"> 1. Move the width and length guides in the tray to the correct positions for the paper loaded. 2. Resend the print job. <p>Is the page or image clipped?</p>	Go to step 2.	The problem is solved.
<p>Step 2</p> <p>From the printer control panel, set the paper size and type in the Paper menu to match the paper loaded in the tray.</p> <p>Do the paper size and type match the paper loaded in the tray?</p>	Go to step 3.	<p>Do one or more of the following:</p> <ul style="list-style-type: none"> • Specify the paper size from the tray settings to match the paper loaded in the tray. • Change the paper loaded in the tray to match the paper size specified in the tray settings.
<p>Step 3</p> <ol style="list-style-type: none"> 1. Depending on your operating system, specify the paper size from Printing Preferences or from the Print dialog. 2. Resend the print job. <p>Is the page or image clipped?</p>	Go to step 4.	The problem is solved.
<p>Step 4</p> <ol style="list-style-type: none"> 1. Reinstall the imaging unit. <ol style="list-style-type: none"> a. Remove the toner cartridge. b. Remove the imaging unit. <p>Warning—Potential Damage: Do not expose the imaging unit to direct light for more than 10 minutes. Extended exposure to light may cause print quality problems.</p> c. Install the imaging unit, and then the cartridge. 2. Resend the print job. <p>Is the page or image clipped?</p>	Contact technical support .	The problem is solved.

Shadow images appear on prints

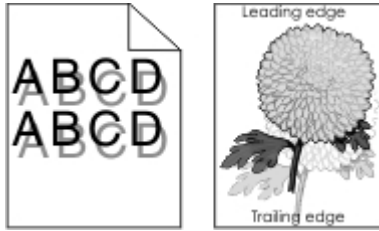

Action	Yes	No
<p>Step 1</p> <p>Load paper with the correct paper type and weight in the tray.</p> <p>Is paper with the correct paper type and weight loaded in the tray?</p>	Go to step 2.	Load paper with the correct paper type and weight in the tray.
<p>Step 2</p> <p>From the printer control panel, set the paper type and weight in the Paper menu to match the paper loaded in the tray.</p> <p>Is the tray set to the type and weight of the paper loaded?</p>	Go to step 3.	Change the paper loaded in the tray to match the paper type and weight specified in the tray settings.
<p>Step 3</p> <ol style="list-style-type: none"> Depending on your operating system, specify the paper type and weight from Printing Preferences or from the Print dialog. Resend the print job. <p>Do shadow images still appear on prints?</p>	Go to step 4.	The problem is solved.

Action	Yes	No
<p>Step 4</p> <p>Replace the imaging unit, and then resend the print job.</p> <p>Do shadow images still appear on prints?</p>	Contact technical support .	The problem is solved.

Gray background on prints

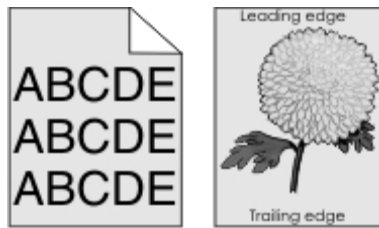

Action	Yes	No
<p>Step 1</p> <ol style="list-style-type: none"> From the Quality Menu on the printer control panel, decrease the toner darkness. <p>Note: 8 is the factory default setting.</p> <ol style="list-style-type: none"> Resend the print job. <p>Did the gray background disappear from the prints?</p>	The problem is solved.	Go to step 2.

Action	Yes	No
<p>Step 2</p> <p>Reinstall the imaging unit and the toner cartridge.</p> <ol style="list-style-type: none"> 1. Remove the toner cartridge. 2. Remove the imaging unit. <p>Warning—Potential Damage: Do not expose the imaging unit to direct light for more than 10 minutes. Extended exposure to light can cause print quality problems.</p> <ol style="list-style-type: none"> 3. Install the imaging unit, and then the cartridge. 4. Resend the print job. <p>Did the gray background disappear from the prints?</p>	The problem is solved.	Go to step 3.
<p>Step 3</p> <p>Replace the imaging unit, and then resend the print job.</p> <p>Did the gray background disappear from the prints?</p>	The problem is solved.	Contact technical support .

Incorrect margins on prints

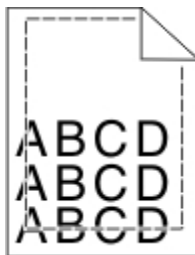

Action	Yes	No
<p>Step 1</p> <ol style="list-style-type: none"> 1. Move the width and length guides in the tray to the correct positions for the paper size loaded. 2. Resend the print job. <p>Are the margins correct?</p>	The problem is solved.	Go to step 2.

User's Guide

Action	Yes	No
<p>Step 2</p> <p>From the printer control panel, set the paper size in the Paper menu to match the paper loaded in the tray.</p> <p>Does the paper size match the paper loaded in the tray?</p>	Go to step 3.	<p>Do one or more of the following:</p> <ul style="list-style-type: none"> • Specify the paper size from the tray settings to match the paper loaded in the tray. • Change the paper loaded in the tray to match the paper size specified in the tray settings.
<p>Step 3</p> <ol style="list-style-type: none"> 1. Depending on your operating system, specify the paper size from Printing Preferences or from the Print dialog. 2. Resend the print job. <p>Are the margins correct?</p>	The problem is solved.	Contact technical support .

Paper curl

Action	Yes	No
<p>Step 1</p> <p>Move the width and length guides in the tray to the correct positions for the size of the paper loaded.</p> <p>Are the width and length guides positioned correctly?</p>	Go to step 2.	Adjust the width and length guides.
<p>Step 2</p> <p>From the printer control panel, set the paper type and weight in the Paper menu to match the paper loaded in the tray.</p> <p>Do the paper type and weight match the type and weight of the paper in the tray?</p>	Go to step 3.	Specify the paper type and weight from the tray settings to match the paper loaded in the tray.

Action	Yes	No
<p>Step 3</p> <ol style="list-style-type: none"> 1. Depending on your operating system, specify the paper type and weight from Printing Preferences or from the Print dialog. 2. Resend the print job. <p>Is the paper still curled?</p>	Go to step 4.	The problem is solved.
<p>Step 4</p> <ol style="list-style-type: none"> 1. Remove the paper from the tray, and then turn it over. 2. Resend the print job. <p>Is the paper still curled?</p>	Go to step 5.	The problem is solved.
<p>Step 5</p> <ol style="list-style-type: none"> 1. Load paper from a fresh package. <p>Note: Paper absorbs moisture due to high humidity. Store paper in its original wrapper until you use it.</p> <ol style="list-style-type: none"> 2. Resend the print job. <p>Is the paper still curled?</p>	Contact technical support .	The problem is solved.

Print irregularities

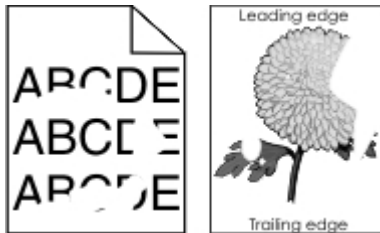

User's Guide

Action	Yes	No
<p>Step 1</p> <ol style="list-style-type: none"> 1. Move the width and length guides in the tray to the correct positions for the size of the paper loaded in the tray. 2. Resend the print job. <p>Do print irregularities still appear?</p>	<p>Go to step 2.</p>	<p>The problem is solved.</p>
<p>Step 2</p> <p>From the printer control panel, set the paper size and type in the Paper menu to match the paper loaded in the tray.</p> <p>Do the printer settings match the type and weight of the paper loaded in the tray?</p>	<p>Go to step 3.</p>	<p>Specify the paper size and type from the tray settings to match the paper loaded in the tray.</p>
<p>Step 3</p> <ol style="list-style-type: none"> 1. Depending on your operating system, specify the paper type and weight from Printing Preferences or from the Print dialog. 2. Resend the print job. <p>Do print irregularities still appear?</p>	<p>Go to step 4.</p>	<p>The problem is solved.</p>
<p>Step 4</p> <p>Check if the paper loaded in the tray has texture or rough finishes.</p> <p>Are you printing on textured or rough paper?</p>	<p>From the printer control panel, set the paper texture in the Paper menu to match the paper loaded in the tray.</p>	<p>Go to step 5.</p>

Action	Yes	No
<p>Step 5</p> <p>1. Load paper from a fresh package.</p> <p>Note: Paper absorbs moisture due to high humidity. Store paper in its original wrapper until you use it.</p> <p>2. Resend the print job.</p> <p>Do print irregularities still appear?</p>	<p>Go to step 6.</p>	<p>The problem is solved.</p>
<p>Step 6</p> <p>Replace the imaging unit, and then resend the print job.</p> <p>Do print irregularities still appear?</p>	<p>Contact technical support.</p>	<p>The problem is solved.</p>

Repeating defects appear on prints

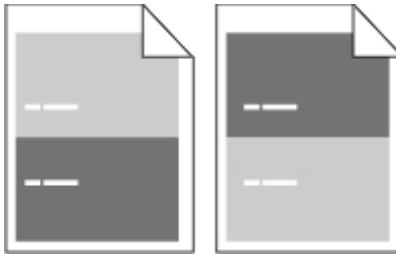

Action	Yes	No
<p>Step 1</p> <p>Measure the distance between the defects.</p> <p>Check for a distance between the defects that equals:</p> <ul style="list-style-type: none"> - 97 mm (3.82 in.) - 47 mm (1.85 in.) - 38 mm (1.5 in.) <p>Is the distance between defects equal to one of the listed measurements?</p>	<p>Go to step 2.</p>	<ol style="list-style-type: none"> 1. Check if the distance between the defects equal to 80 mm (3.15 in.) 2. Take note of the distance, and then contact technical support.
<p>Step 2</p> <p>Replace the imaging unit, and then resend the print job.</p> <p>Do the repeating defects still appear?</p>	<p>Contact technical support.</p>	<p>The problem is solved.</p>

Print is too dark

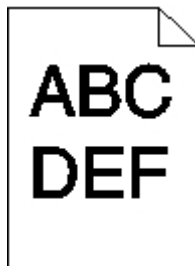

User's Guide

Action	Yes	No
<p>Step 1</p> <p>1. From the Quality menu on the printer control panel, reduce the toner darkness.</p> <p>Note: 8 is the factory default setting.</p> <p>2. Resend the print job.</p> <p>Is the print still too dark?</p>	<p>Go to step 2.</p>	<p>The problem is solved.</p>
<p>Step 2</p> <p>1. From the printer control panel, set the paper type, texture and weight in the Paper menu to match the paper loaded in the tray.</p> <p>2. Resend the print job.</p> <p>Is the tray set to the type, texture, and weight of the paper loaded?</p>	<p>Go to step 3.</p>	<p>Do one or more of the following:</p> <ul style="list-style-type: none"> • Specify the paper type, texture, and weight from the tray settings to match the paper loaded in the tray. • Change the paper loaded in the tray to match the paper type, texture and weight specified in the tray settings.
<p>Step 3</p> <p>1. Depending on your operating system, specify the paper type, texture and weight from Printing Preferences or from the Print dialog.</p> <p>2. Resend the print job.</p> <p>Is the print still too dark?</p>	<p>Go to step 4.</p>	<p>The problem is solved.</p>
<p>Step 4</p> <p>Check if the paper loaded in the tray has texture or rough finishes.</p> <p>Are you printing on textured or rough paper?</p>	<p>From the printer control panel, change the texture settings in the Paper Texture menu to match the paper you are printing on.</p>	<p>Go to step 5.</p>

User's Guide

Action	Yes	No
<p>Step 5</p> <p>1. Load paper from a fresh package.</p> <p>Note: Paper absorbs moisture due to high humidity. Store paper in its original wrapper until you use it.</p> <p>2. Resend the print job.</p> <p>Is the print still too dark?</p>	Go to step 6.	The problem is solved.
<p>Step 6</p> <p>Replace the imaging unit, and then resend the print job.</p> <p>Is the print still too dark?</p>	Contact technical support .	The problem is solved.

Print is too light



Action	Yes	No
<p>Step 1</p> <p>1. From the Quality menu on the printer control panel, increase the toner darkness.</p> <p>Note: 8 is the factory default setting.</p> <p>2. Resend the print job.</p> <p>Is the print still too light?</p>	Go to step 2.	The problem is solved.

User's Guide

Action	Yes	No
<p>Step 2</p> <p>From the printer control panel, set the paper type, texture, and weight in the Paper menu to match the paper loaded in the tray.</p> <p>Is the tray set to the type, texture, and weight of the paper loaded?</p>	Go to step 3.	Change the paper type, texture, and weight to match the paper loaded in the tray.
<p>Step 3</p> <ol style="list-style-type: none"> Depending on your operating system, specify the paper type, texture, and weight from Printing Preferences or from the Print dialog. Resend the print job. <p>Is the print still too light?</p>	Go to step 4.	The problem is solved.
<p>Step 4</p> <p>Make sure that the paper has no texture or rough finishes.</p> <p>Are you printing on textured or rough paper?</p>	From the printer control panel, change the texture settings in the Paper Texture menu to match the paper you are printing on.	Go to step 5.
<p>Step 5</p> <ol style="list-style-type: none"> Load paper from a fresh package. <p>Note: Paper absorbs moisture due to high humidity. Store paper in its original wrapper until you use it.</p> <ol style="list-style-type: none"> Resend the print job. <p>Is the print still too light?</p>	Go to step 6.	The problem is solved.

Action	Yes	No
<p>Step 6</p> <p>1. Redistribute the toner in the imaging unit.</p> <ol style="list-style-type: none"> a. Remove the toner cartridge, and then the imaging unit. b. Firmly shake the imaging unit. <p>Warning—Potential Damage: Do not expose the imaging unit to direct light for more than 10 minutes. Extended exposure to light may cause print quality problems.</p> <ol style="list-style-type: none"> c. Install the imaging unit, and then the cartridge. <p>2. Resend the print job.</p> <p>Is the print still too light?</p>	<p>Go to step 7.</p>	<p>The problem is solved.</p>
<p>Step 7</p> <p>Replace the imaging unit, and then resend the print job.</p> <p>Is the print still too light?</p>	<p>Contact technical support.</p>	<p>The problem is solved.</p>

Printer is printing blank pages

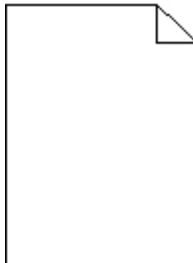

User's Guide

Action	Yes	No
<p>Step 1</p> <ol style="list-style-type: none"> 1. Check if there is packing material left on the imaging unit. <ol style="list-style-type: none"> a. Remove the toner cartridge, and then the imaging unit. b. Check if the packing material is properly removed from the imaging unit. <p>Warning—Potential Damage: Do not expose the imaging unit to direct light for more than 10 minutes. Extended exposure to light may cause print quality problems.</p> c. Reinstall the imaging unit, and then the cartridge. 2. Resend the print job. <p>Is the printer still printing blank pages?</p>	<p>Go to step 2.</p>	<p>The problem is solved.</p>
<p>Step 2</p> <ol style="list-style-type: none"> 1. Redistribute the toner in the imaging unit. <ol style="list-style-type: none"> a. Remove the toner cartridge, and then the imaging unit. b. Firmly shake the imaging unit. <p>Warning—Potential Damage: Do not expose the imaging unit to direct light for more than 10 minutes. Extended exposure to light may cause print quality problems.</p> c. Reinstall the imaging unit, and then the cartridge. 2. Resend the print job. <p>Is the printer still printing blank pages?</p>	<p>Go to step 3.</p>	<p>The problem is solved.</p>
<p>Step 3</p> <p>Replace the imaging unit, and then resend the print job.</p> <p>Is the printer still printing blank pages?</p>	<p>Contact technical support.</p>	<p>The problem is solved.</p>

Skewed print



Action	Yes	No
<p>Step 1</p> <ol style="list-style-type: none"> 1. Move the width and length guides in the tray to the correct positions for the size of the paper loaded. 2. Resend the print job. <p>Is the print still skewed?</p>	Go to step 2.	The problem is solved.
<p>Step 2</p> <ol style="list-style-type: none"> 1. Check if you are printing on a paper that is supported by the tray. 2. Resend the print job. <p>Is the print still skewed?</p>	Contact technical support .	The problem is solved.

Printer is printing solid black pages



Action	Yes	No
<p>Step 1</p> <p>1. Reinstall the imaging unit.</p> <p style="padding-left: 20px;">a. Remove the toner cartridge, and then the imaging unit.</p> <p style="padding-left: 40px;">Warning—Potential Damage: Do not expose the imaging unit to direct light for more than 10 minutes. Extended exposure to light may cause print quality problems.</p> <p style="padding-left: 20px;">b. Install the imaging unit, and then the cartridge.</p> <p>2. Resend the print job.</p> <p>Is the printer printing solid black pages?</p>	Go to step 2.	The problem is solved.
<p>Step 2</p> <p>Replace the imaging unit, and then resend the print job.</p> <p>Is the printer printing solid black pages?</p>	Contact technical support .	The problem is solved.

Transparency print quality is poor

Action	Yes	No
<p>Step 1</p> <p>From the printer control panel, set the paper type in the Paper menu to match the paper loaded in the tray.</p> <p>Is the paper type for the tray set to Transparency?</p>	Go to step 2.	Set the paper type to Transparency.
<p>Step 2</p> <p>1. Check if you are using a recommended type of transparency.</p> <p>2. Resend the print job.</p> <p>Is the print quality still poor?</p>	Contact technical support .	The problem is solved.

Streaked horizontal lines appear on prints

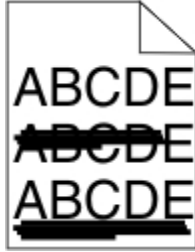

Action	Yes	No
<p>Step 1</p> <ol style="list-style-type: none"> Depending on your operating system, specify the tray or feeder from Printing Preferences or the Print dialog. Resend the print job. <p>Do streaked horizontal lines appear on prints?</p>	Go to step 2.	The problem is solved.
<p>Step 2</p> <p>From the printer control panel, set the paper type and weight in the Paper menu to match the paper loaded in the tray.</p> <p>Do the paper type and weight match the type and weight of the paper in the tray?</p>	Go to step 3.	Change the paper type and weight to match the paper loaded in the tray.
<p>Step 3</p> <ol style="list-style-type: none"> Load paper from a fresh package. <p>Note: Paper absorbs moisture due to high humidity. Store paper in its original wrapper until you use it.</p> <ol style="list-style-type: none"> Resend the print job. <p>Do streaked horizontal lines appear on prints?</p>	Go to step 4.	The problem is solved.

Action	Yes	No
<p>Step 4</p> <p>1. Reinstall the imaging unit.</p> <p style="padding-left: 20px;">a. Remove the toner cartridge, and then the imaging unit.</p> <p style="padding-left: 40px;">Warning—Potential Damage: Do not expose the imaging unit to direct light for more than 10 minutes. Extended exposure to light may cause print quality problems.</p> <p style="padding-left: 20px;">b. Install the imaging unit, and then the cartridge.</p> <p>2. Resend the print job.</p> <p>Do streaked horizontal lines appear on prints?</p>	Go to step 5.	The problem is solved.
<p>Step 5</p> <p>Replace the imaging unit, and then resend the print job.</p> <p>Do streaked horizontal lines appear on prints?</p>	Contact technical support .	The problem is solved.

Streaked vertical lines appear on prints

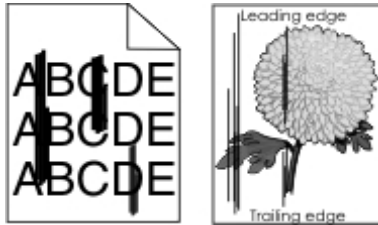

Action	Yes	No
<p>Step 1</p> <p>1. Depending on your operating system, specify the paper type, texture, and weight from Printing Preferences or from the Print dialog.</p> <p>2. Resend the print job.</p> <p>Do streaked vertical lines appear on prints?</p>	Go to step 2.	The problem is solved.

User's Guide

Action	Yes	No
<p>Step 2</p> <p>From the printer control panel, set the paper texture, type, and weight in the Paper menu to match the paper loaded in the tray.</p> <p>Do the paper texture, type, and weight match the paper in the tray?</p>	<p>Go to step 3.</p>	<p>Do one or more of the following:</p> <ul style="list-style-type: none"> • Specify the paper texture, type, and weight from the tray settings to match the paper loaded in the tray. • Change the paper loaded in the tray to match the paper texture, type, and weight specified in the tray settings.
<p>Step 3</p> <ol style="list-style-type: none"> 1. Load paper from a fresh package. <p>Note: Paper absorbs moisture due to high humidity. Store paper in its original wrapper until you use it.</p> <ol style="list-style-type: none"> 2. Resend the print job. <p>Do streaked vertical lines appear on prints?</p>	<p>Go to step 4.</p>	<p>The problem is solved.</p>
<p>Step 4</p> <ol style="list-style-type: none"> 1. Reinstall the imaging unit. <ol style="list-style-type: none"> a. Remove the toner cartridge, and then the imaging unit. <p>Warning—Potential Damage: Do not expose the imaging unit to direct light for more than 10 minutes. Extended exposure to light may cause print quality problems.</p> <ol style="list-style-type: none"> b. Install the imaging unit, and then the cartridge. 2. Resend the print job. <p>Do streaked vertical lines appear on prints?</p>	<p>Go to step 5.</p>	<p>The problem is solved.</p>
<p>Step 5</p> <p>Replace the imaging unit, and then resend the print job.</p> <p>Do streaked vertical lines appear on prints?</p>	<p>Contact technical support.</p>	<p>The problem is solved.</p>

Horizontal voids appear on prints



Action	Yes	No
<p>Step 1</p> <ol style="list-style-type: none"> 1. Make sure your software program is using a correct fill pattern. 2. Resend the print job. <p>Do horizontal voids appear on prints?</p>	Go to step 2.	The problem is solved.
<p>Step 2</p> <ol style="list-style-type: none"> 1. Load the specified tray or feeder with a recommended type of paper. 2. Resend the print job. <p>Do horizontal voids appear on prints?</p>	Go to step 3.	The problem is solved.
<p>Step 3</p> <ol style="list-style-type: none"> 1. Redistribute the toner in the imaging unit. <ol style="list-style-type: none"> a. Remove the toner cartridge, and then the imaging unit. b. Firmly shake the imaging unit. <p>Warning—Potential Damage: Do not expose the imaging unit to direct light for more than 10 minutes. Extended exposure to light may cause print quality problems.</p> <ol style="list-style-type: none"> c. Reinstall the imaging unit, and then the cartridge. 2. Resend the print job. <p>Do horizontal voids appear on prints?</p>	Go to step 4.	The problem is solved.

Action	Yes	No
<p>Step 4</p> <p>Replace the imaging unit, and then resend the print job.</p> <p>Do horizontal voids appear on prints?</p>	<p>Contact technical support.</p>	<p>The problem is solved.</p>

Vertical voids appear on prints

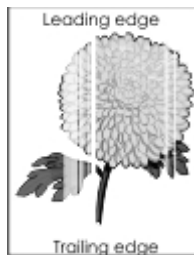

Action	Yes	No
<p>Step 1</p> <ol style="list-style-type: none"> 1. Make sure your software program is using a correct fill pattern. 2. Resend the print job. <p>Do vertical voids appear on prints?</p>	<p>Go to step 2.</p>	<p>The problem is solved.</p>
<p>Step 2</p> <ol style="list-style-type: none"> 1. From the printer control panel, set the paper type and weight in the Paper menu to match the paper loaded in the tray. 2. Resend the print job. <p>Do vertical voids appear on prints?</p>	<p>Go to step 3.</p>	<p>The problem is solved.</p>

User's Guide

Action	Yes	No
<p>Step 3</p> <p>Check if you are using a recommended type of paper.</p> <ol style="list-style-type: none"> 1. Load the indicated tray or feeder with a recommended type of paper. 2. Resend the print job. <p>Do vertical voids appear on prints?</p>	<p>Go to step 4.</p>	<p>The problem is solved.</p>
<p>Step 4</p> <ol style="list-style-type: none"> 1. Redistribute the toner in the imaging unit. <ol style="list-style-type: none"> a. Remove the toner cartridge, and then the imaging unit. b. Firmly shake the imaging unit. <p>Warning—Potential Damage: Do not expose the imaging unit to direct light for more than 10 minutes. Extended exposure to light may cause print quality problems.</p> <ol style="list-style-type: none"> c. Reinstall the imaging unit, and then the cartridge. 2. Resend the print job. <p>Do vertical voids appear on prints?</p>	<p>Contact technical support.</p> <p>Note: The laser scanning unit may be defective.</p>	<p>The problem is solved.</p>

Toner specks appear on prints

Action	Yes	No
<p>Replace the imaging unit, and then resend the print job.</p> <p>Do toner specks appear on prints?</p>	<p>Contact technical support.</p>	<p>The problem is solved.</p>

Toner fog or background shading appears on prints

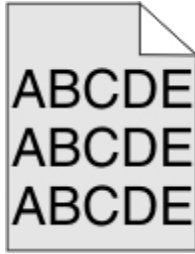

Action	Yes	No
<p>Step 1</p> <p>Reinstall the imaging unit.</p> <ol style="list-style-type: none"> 1. Remove, and then install the imaging unit. 2. Resend the print job. <p>Does fog or shading appear on prints?</p>	<p>Go to step 2.</p>	<p>The problem is solved.</p>
<p>Step 2</p> <p>Replace the imaging unit, and then resend the print job.</p> <p>Does fog or shading appear on prints?</p>	<p>Contact technical support.</p>	<p>The problem is solved.</p>

Toner rubs off

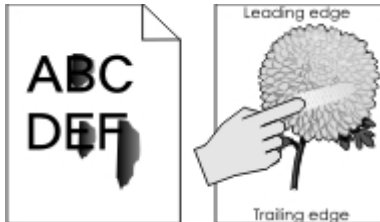

Action	Yes	No
<p>Step 1</p> <p>From the Paper menu on the printer control panel, check the paper type, texture, and weight.</p> <p>Do the paper type, texture, and weight match the paper loaded in the tray?</p>	Go to step 2.	Specify the paper type, texture, and weight from the tray settings to match the paper loaded in the tray.
<p>Step 2</p> <p>Resend the print job.</p> <p>Does the toner still rub off?</p>	Contact technical support .	The problem is solved.





Uneven print density

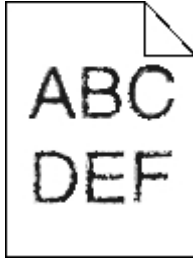

Action	Yes	No
<p>Replace the imaging unit, and then resend the print job.</p> <p>Is the print density uneven?</p>	Contact technical support .	The problem is solved.

Characters have jagged or uneven edges



Action	Yes	No
<p>Step 1</p> <ol style="list-style-type: none"> 1. Print a font sample list to check if the fonts you are using are supported by the printer. <ol style="list-style-type: none"> a. From the printer control panel, navigate to: <div style="display: flex; align-items: center; gap: 5px; margin: 5px 0;">  >Reports >  >Print Fonts >  </div> b. Press the arrow buttons until PCL Fonts or PostScript Fonts appears, and then press  . 2. Use a font that is supported by the printer or install the font that you want to use. For more information, contact your system support person. 3. Resend the print job. <p>Do prints still contain characters that have jagged or uneven edges?</p>	<p>Go to step 2.</p>	<p>The problem is solved.</p>
<p>Step 2</p> <ol style="list-style-type: none"> 1. Use a font that is supported by the printer or install the font that you want to use in your computer. For more information, contact your system support person. 2. Resend the print job. <p>Do prints still contain characters that have jagged or uneven edges?</p>	<p>Contact technical support.</p>	<p>The problem is solved.</p>

Embedded Web Server does not open

Action	Yes	No
<p>Step 1</p> <ol style="list-style-type: none"> 1. Turn on the printer. 2. Open a Web browser, and then type the printer IP address. 3. Press Enter. <p>Does the Embedded Web Server open?</p>	<p>The problem is solved.</p>	<p>Go to step 2.</p>
<p>Step 2</p> <p>Make sure the printer IP address is correct.</p> <ol style="list-style-type: none"> 1. View the printer IP address: <ul style="list-style-type: none"> - From the TCP/IP section in the Network/Ports menu - By printing a network setup page or menu settings page, and then finding the TCP/IP section <p>Note: An IP address appears as four sets of numbers separated by periods, such as 123.123.123.123.</p> 2. Open a Web browser, and then type the IP address. <p>Note: Depending on the network settings, you may need to type "https://" instead of "http://" before the printer IP address to access the Embedded Web Server.</p> 3. Press Enter. <p>Does the Embedded Web Server open?</p>	<p>The problem is solved.</p>	<p>Go to step 3.</p>

User's Guide

Action	Yes	No
<p>Step 3</p> <p>Check if the network is working.</p> <ol style="list-style-type: none"> 1. Print a network setup page. 2. Check the first section of the network setup page and confirm that the status is Connected. <p>Note: If the status is Not Connected, then the connection may be intermittent, or the network cable may be defective. Contact your system support person for a solution, and then print another network setup page.</p> <ol style="list-style-type: none"> 3. Open a Web browser, and then type the printer IP address. 4. Press Enter. <p>Does the Embedded Web Server open?</p>	<p>The problem is solved.</p>	<p>Go to step 4.</p>
<p>Step 4</p> <p>Check if the cable connections to the printer and print server are secure.</p> <ol style="list-style-type: none"> 1. Connect the cables properly. For more information, see the setup documentation that came with the printer. 2. Open a Web browser, and then type the printer IP address. 3. Press Enter. <p>Does the Embedded Web Server open?</p>	<p>The problem is solved.</p>	<p>Go to step 5.</p>
<p>Step 5</p> <p>Temporarily disable the Web proxy servers.</p> <p>Proxy servers may block or restrict you from accessing certain Web sites including the Embedded Web Server.</p> <p>Does the Embedded Web Server open?</p>	<p>The problem is solved.</p>	<p>Contact your system support person.</p>

Contacting technical support

When you contact technical support, describe the problem you are experiencing, the message on the printer display, and the troubleshooting steps you have already taken to find a solution.

You need to know your printer model type and serial number. For more information, see the label on the inside top front cover or at the back of the printer. The serial number is also listed on the menu settings page.

KONICA MINOLTA Web site at <http://www.konicaminolta.com>.

15—Notices

Copyright notice

Copyright © 2015 KONICA MINOLTA, INC., JP Tower, 2-7-2 Marunouchi, Chiyoda-ku, Tokyo, 100-7014, Japan. All Rights Reserved. This document may not be copied, in whole or part, nor transferred to any other media or language, without written permission of KONICA MINOLTA, INC.

Edition notice

KONICA MINOLTA, INC. reserves the right to make changes to this guide and to the equipment described herein without notice. Considerable effort has been made to ensure that this guide is free of inaccuracies and omissions.

However, KONICA MINOLTA, INC. makes no warranty of any kind including, but not limited to, any implied warranties of merchantability and fitness for a particular purpose with regard to this guide. KONICA MINOLTA, INC. assumes no responsibility for, or liability for, errors contained in this guide or for incidental, special, or consequential damages arising out of the furnishing of this guide, or the use of this guide in operating the equipment, or in connection with the performance of the equipment when so operated.

Trademarks

KONICA MINOLTA, the KONICA MINOLTA logo, PageScope, and bizhub are registered trademarks or trademarks of KONICA MINOLTA, INC.

Mac and the Mac logo are trademarks of Apple Inc., registered in the U.S. and other countries.

PCL® is a registered trademark of the Hewlett-Packard Company. PCL is Hewlett-Packard Company's designation of a set of printer commands (language) and functions included in its printer products. This printer is intended to be compatible with the PCL language. This means the printer recognizes PCL commands used in various application programs, and that the printer emulates the functions corresponding to the commands.

All other trademarks are the property of their respective owners.

Software License Agreement

This package contains the following materials provided by KONICA MINOLTA, INC. (KM): software included as part of the printing system ("Printing Software"), the digitally-encoded machine-readable outline data encoded in the special format and in the encrypted form ("Font Programs"), other software which runs on a computer system for use in conjunction with the Printing Software ("Host Software"), and related explanatory written materials ("Documentation"). The term "Software" shall be used to describe Printing Software, Font Programs and/or Host Software and also include any upgrades, modified versions, additions, and copies of the Software.

The Software is being licensed to you under the terms of this Agreement.

KM grants to you a non-exclusive sublicense to use the Software and Documentation, provided that you agree to the following:

User's Guide

1. You may use the Software and accompanying Font Programs for imaging to the licensed output device(s), solely for your own internal business purposes.
2. In addition to the license for Font Programs set forth in Section 1 above, you may use Roman Font Programs to reproduce weights, styles, and versions of letters, numerals, characters and symbols ("Typefaces") on the display or monitor for your own internal business purposes.
3. You may make one backup copy of the Host Software, provided your backup copy is not installed or used on any computer. Notwithstanding the above restrictions, you may install the Host Software on any number of computers solely for use with one or more printing systems running the Printing Software.
4. You may assign its rights under this Agreement to an assignee of all of Licensee's right and interest to such Software and Documentation ("Assignee") provided you transfer to Assignee all copies of such Software and Documentation Assignee agrees to be bound by all of the terms and conditions of this Agreement.
5. You agree not to modify, adapt or translate the Software and Documentation.
6. You agree that you will not attempt to alter, disassemble, decrypt, reverse engineer or decompile the Software.
7. Title to and ownership of the Software and Documentation and any reproductions thereof shall remain with KM and its licensor.
8. Trademarks shall be used in accordance with accepted trademark practice, including identification of the trademark owner's name. Trademarks can only be used to identify printed output produced by the Software. Such use of any trademark does not give you any rights of ownership in that trademark.
9. You may not rent, lease, sublicense, lend or transfer versions or copies of the Software Licensee does not use, or Software contained on any unused media, except as part of the permanent transfer of all Software and Documentation as described above.
10. IN NO EVENT WILL KM OR ITS LICENSOR BE LIABLE TO YOU FOR ANY CONSEQUENTIAL, INCIDENTAL INDIRECT, PUNITIVE OR SPECIAL DAMAGES, INCLUDING ANY LOST PROFITS OR LOST SAVING, EVEN IF KM HAS BEEN ADVISED OF THE POSSIBILITY OF SUCH DAMAGES, OR FOR ANY CLAIM BY ANY THIRD PARTY. KM OR ITS LICENSOR DISCLAIMS ALL WARRANTIES WITH REGARD TO THE SOFTWARE, EXPRESS OR IMPLIED, INCLUDING, WITHOUT LIMITATION IMPLIED WARRANTIES OF MERCHANTABILITY, FITNESS FOR A PARTICULAR PURPOSE, TITLE AND NON-INFRINGEMENT OF THIRD PARTY RIGHTS. SOME STATES OR JURISDICTIONS DO NOT ALLOW THE EXCLUSION OR LIMITATION OF INCIDENTAL, CONSEQUENTIAL OR SPECIAL DAMAGES, SO THE ABOVE LIMITATIONS MAY NOT APPLY TO YOU.
11. Notice to Government End Users: The Software is a "commercial item," as that term is defined at 48 C.F.R.2.101, consisting of "commercial computer software" and "commercial computer software documentation," as such terms are used in 48 C.F.R. 12.212. Consistent with 48 C.F.R. 12.212 and 48 C.F.R. 227.7202-1 through 227.7202-4, all U.S. Government End Users acquire the Software with only those rights set forth herein.
12. You agree that you will not export the Software in any form in violation of any applicable laws and regulations regarding export control of any countries.

Legal restrictions on reproduction

Certain types of originals must never be reproduced with the purpose or intent to pass reproductions of such originals off as the originals.

The following is not a complete list, but is meant to be used as a guide to responsible reproduction.

<Financial Instruments>

- Personal checks
- Traveler's checks
- Money orders
- Certificates of deposit
- Bonds or other certificates of indebtedness
- Stock certificates

<Legal Originals>

- Food stamps
- Postage stamps (canceled or uncanceled)
- checks or drafts drawn by government agencies
- Internal revenue stamps (canceled or uncanceled)
- Passports
- Immigration papers
- Motor vehicle licenses and titles
- House and property titles and deeds

<General>

- Identification cards, badges, or insignias
- Copyrighted works without permission of the copyright owner

In addition, it is prohibited under any circumstances to reproduce domestic or foreign currencies, or works of art without permission of the copyright owner.

When in doubt about the nature of an original, consult with legal counsel.

FIRMWARE UPDATES

FIRMWARE UPDATES MAY MODIFY PRINTER SETTINGS AND CAUSE COUNTERFEIT AND/OR UNAUTHORIZED PRODUCTS, SUPPLIES, PARTS, MATERIALS (SUCH AS TONERS AND INKS), SOFTWARE, OR INTERFACES TO STOP WORKING. AUTHORIZED USE OF GENUINE PRODUCTS WILL NOT BE IMPACTED.

PRINTER LICENSE

The patented printer is licensed for, and designed to work with only genuine toner and/or ink cartridges (and developer components, in the case of a laser printer) made by the manufacturer of this printer for the life of the patented printer. Under this patent license, you agree to: (1) use only genuine toner and/or ink cartridges made by the manufacturer of this printer with this licensed printer except as otherwise provided below, (2) if the patented printer is a laser printer, use only genuine developer components made by the manufacturer of this printer with this licensed laser printer except as otherwise provided below, and (3) pass this license/agreement to any subsequent user of this licensed printer. The patented toner and/or ink cartridges (and developer components in the case of a laser printer) inside are licensed subject to a restriction that they may be used only once. Following their initial use, you agree to return them only to us or the manufacturer for recycling. Please contact us for information regarding free empty toner cartridge returns. The genuine toner and/or ink cartridges are designed to stop working after delivering a fixed amount of toner and/or ink. A variable amount of toner and/or ink may remain in them when replacement is required. If you do not accept the terms of this single use license/agreement; return this product in its original packaging to your point of purchase. Replacement toner and/or ink cartridge(s) sold without these terms are available. Please contact us or your place of purchase for more information regarding the availability of these regular cartridges. Please be aware that a regular cartridge, that is cartridges not sold subject to this single use patent license, may be refilled by you, or a third party, as the only cartridge alternative to be used with the licensed printer.

CARTRIDGE LICENSE AGREEMENT

I agree that the patented print cartridge(s) shipped with this printing device is (are) sold subject to the following license/agreement: The patented print cartridge(s) contained inside is (are) licensed for a single use only and is (are) designed to stop working after the delivery of a fixed amount of toner/ink. A variable amount of toner/ink will remain in the cartridge when replacement is required. After this single use, the license/right to use the print cartridge terminates and the used cartridge must be returned only to the manufacturer for remanufacturing, refilling or recycling. If I buy another cartridge in the future that is sold subject to the same or similar terms, I hereby accept such terms as to that cartridge as well. If you do not accept the terms of this single use license/agreement; return this product in its original packaging to your point of purchase. Replacement cartridges sold without these terms are available. Please contact us or your place of purchase for more information regarding the availability of these regular cartridges.

Fuser/Imaging Unit License - Single Use: Please read before opening.

Opening this package or using the patented fuser and/or imaging unit inside confirms your acceptance of the following license/agreement. The patented fuser and imaging unit are each sold at a special price subject to a patent restriction that each be used only once. Following the initial use, you agree to return the fuser and/or imaging unit only to the manufacturer for remanufacture and/or recycling. The fuser and imaging unit are designed to stop working once they reach their respective rated life (as established by the manufacturer). If you do not accept these terms, return the unopened package to your point of purchase. Replacement fuser(s) and imaging unit(s) sold without these terms are available.

Noise emission levels

The following measurements were made in accordance with ISO 7779 and reported in conformance with ISO 9296.

Note: Some modes may not apply to your product.

1-meter average sound pressure, dBA	
Printing (Simplex / Duplex)	53dBA / 52dBA
Ready	15dBA

For EU member states only

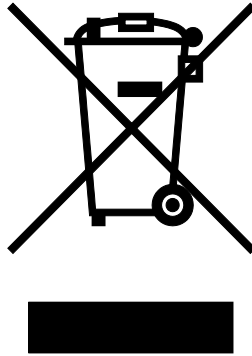

This symbol means: **Do not dispose of this product together with your household waste!**

Please contact the Local Authority for appropriate disposal instructions. In the case of a new device being purchased, the used one can also be given to our dealer for appropriate disposal. Recycling of this product will help to conserve natural resources and prevent potential negative consequences for the environment and human health caused by inappropriate waste handling.

This product complies with RoHS (2002/95/EC) directive.

India E-Waste notice

This product complies with the India E-Waste (Management and Handling) Rules, 2011, which prohibit use of lead, mercury, hexavalent chromium, polybrominated biphenyls, or polybrominated diphenyl ethers in concentrations exceeding 0.1% by weight and 0.01% by weight for cadmium, except for the exemption set in Schedule II of the Rules.

Product disposal

Do not dispose of the printer or supplies in the same manner as normal household waste. Consult your local authorities for disposal and recycling options.

ENERGY STAR



As an ENERGY STAR® Partner, we have determined that this machine meets the ENERGY STAR Guidelines for energy efficiency.

What is an ENERGY STAR product?

An ENERGY STAR product has a special feature that allows it to automatically switch to a “low-power mode” after a period of inactivity. An ENERGY STAR product uses energy more efficiently, saves you money on utility bills and helps protect the environment.

Temperature information

Ambient operating temperature	15.6 to 32.2°C (60 to 90°F)
Shipping temperature	-40 to 43.3°C (-40 to 110°F)
Storage temperature and relative humidity	1 to 35°C (34 to 95°F) 8 to 80% RH

Power consumption

Product power consumption

The following table documents the power consumption characteristics of the product.

Note: Some modes may not apply to your product.

Mode	Description	Power consumption (Watts)
Printing	The product is generating hard-copy output from electronic inputs.	520 (one-sided), 340 (two-sided)
Copy	The product is generating hard-copy output from hard-copy original documents.	NA
Scan	The product is scanning hard-copy documents.	NA

Mode	Description	Power consumption (Watts)
Ready	The product is waiting for a print job.	7
Sleep Mode	The product is in a high-level energy-saving mode.	3
Hibernate	The product is in a low-level energy-saving mode.	0.5
Off	The product is plugged into an electrical outlet, but the power switch is turned off.	0.0

The power consumption levels listed in the previous table represent time-averaged measurements. Instantaneous power draws may be substantially higher than the average.

Sleep Mode

This product is designed with an energy-saving mode called *Sleep Mode*. The Sleep Mode saves energy by lowering power consumption during extended periods of inactivity. The Sleep Mode is automatically engaged after this product is not used for a specified period of time, called the *Sleep Mode Timeout*.

Factory default Sleep Mode Timeout for this product (in minutes):	20
---	----

By using the configuration menus, the Sleep Mode Timeout can be modified between 1 minute and 120 minutes. Setting the Sleep Mode Timeout to a low value reduces energy consumption, but may increase the response time of the product. Setting the Sleep Mode Timeout to a high value maintains a fast response, but uses more energy.

Hibernate Mode

This product is designed with an ultra-low power operating mode called *Hibernate mode*. When operating in Hibernate Mode, all other systems and devices are powered down safely.

The Hibernate mode can be entered in any of the following methods:

- Using the Hibernate Timeout
- Using the Schedule Power modes
- Using the Sleep/Hibernate button

Factory default Hibernate Timeout for this product in all countries or regions	3 days
--	--------

The amount of time the printer waits after a job is printed before it enters Hibernate mode can be modified between one hour and one month.

Off mode

If this product has an off mode which still consumes a small amount of power, then to completely stop product power consumption, disconnect the power supply cord from the electrical outlet.

Total energy usage

It is sometimes helpful to calculate the total product energy usage. Since power consumption claims are provided in power units of Watts, the power consumption should be multiplied by the time the product spends in each mode in order to calculate energy usage. The total product energy usage is the sum of each mode's energy usage.